

Teamsters  
Construction Industry  
Safety & Health Training



10-Hour OSHA Construction  
Safety & Health Outreach Course



Electronic Version is Section 508 Compliant

# **Teamsters**

**10-Hour OSHA Construction Safety & Health Outreach Course**

**Electronic version is 508 Compliant**

**2012 Edition**

The project described was supported by Award Number U45ES014084 and U45ES014103 from the National Institute Of Environmental Health Sciences. The content is solely the responsibility of the authors and does not necessarily represent the official views of the National Institute Of Environmental Health Sciences or the National Institutes of Health.

© Copyright 2012

International Brotherhood of Teamsters

Safety & Health Department

25 Louisiana Ave. N.W.

Washington, D.C. 20001

(202) 624-6963

[ibt\\_niehsgrant@teamster.org](mailto:ibt_niehsgrant@teamster.org)

[www.teamster.org](http://www.teamster.org)



# Table of Contents

Module 1: Introduction to OSHA .....	10
Module 2: Fall Protection .....	24
Module 3: Electrical Safety .....	40
Module 4: Struck-By and Caught-In Hazards.....	54
Module 5: Personal Protective Equipment .....	62
Module 6: Health Hazards and HAZCOM.....	76
Module 7: Stairways and Ladders.....	96
Module 8: Materials Handling, Storage, and Disposal.....	106
Module 9: Tools - Hand and Power.....	120
Module 10: Scaffolds .....	132
Module 11: Cranes, Derricks, Hoists, Elevators and Conveyors ..	152
Module 12: Excavations .....	168
Module 13: Heat, Noise & Ergonomic Hazards.....	184
Module 14: Fire Prevention Plans and Fire Protection .....	196
Module 15: Confined Spaces .....	210
Module 16: Motor Vehicles .....	220

## **Preface**

This manual covers the topics that OSHA prescribes for 10-hour courses under the OSHA Construction Industry Outreach Safety and Health Training Program. This course may only be taught by authorized instructors who have successfully completed the OSHA Construction Industry Trainer Course, OSHA 500.

This manual was prepared by the Worker Training Program of the International Brotherhood of Teamsters - the Teamsters Union - with funds from the National Institute of Environmental Health Sciences.

---

## **OSHA Outreach Training Program Guidelines**

The requirements of the OSHA Outreach Training Program for the Construction Industry are outlined on the following page. You may download a complete copy of OSHA's Guidelines for this program at [www.osha.gov](http://www.osha.gov) (Click on "Training").

---

## **Course Requirements**

This is a basic, introductory safety and health course, and there is no prerequisite for taking it. There is also no required refresher for this course, although employers and employees might benefit if workers took this course again from time to time.

This course may be taught over a period of time, no longer than six months, with each session lasting at least one hour.

Although OSHA prescribes the topics that must be included in this course, the specific content of each topic should be chosen to best meet the needs of the workers involved, taking into account their job tasks, and the hazards that they encounter.

OSHA subpart references are provided for informational purposes; training should emphasize hazard awareness.



# 10-Hour Construction Industry Outreach Training Program

## OSHA Required Topics

### **Mandatory - 5 hours**

#### **Introduction to OSHA** (at least two hours)

The OSH Act, General Duty Clause, Employer and Employee Rights and Responsibilities, Whistle-blower Rights, Record Keeping Basics, Inspections, Citations, and Penalties, General Safety and Health Provisions, Competent Person, Subpart C, Value of Safety and Health, OSHA Web Site and Available Resources, OSHA 800 Number.

#### **OSHA Focus Four Hazards** - Two hours (minimum 15 minutes on each of four areas)

- Fall Protection, Subpart M
- Electrical, Subpart K
- Struck by (e.g., falling objects, trucks, cranes)
- Caught in-between (e.g., trench hazards, equipment)

#### **Personal Protective and Lifesaving Equipment** - Subpart E (30 minutes)

**Health Hazards in Construction** (30 minutes) (e.g., noise, hazard communication, crystalline silica)

### **Elective - 2 hours**

Choose at least two of the following elective topics- these topics must add up to at least two hours (a minimum one-half hour each)

- **Materials Handling, Storage, Use and Disposal**, Subpart H
- **Tools - Hand and Power**, Subpart I
- **Scaffolds**, Subpart L
- **Cranes, Derricks, Hoists, Elevators, & Conveyors**, Subpart N
- **Excavations**, Subpart P
- **Stairways and Ladders**, Subpart X

### **Optional – 3 hours**

For the remaining three class hours: Teach any other construction industry hazards or policies and/or expand on the mandatory or elective topics. Instructional time must be at least 10 hours

## About the Teamsters

The International Brotherhood of Teamsters, with 1.4 million members, is one of the largest labor unions in the world. It is also the most diverse union in the United States. The Teamsters represent all types of workers - from airline pilots to zookeepers. One out of every ten union members is a Teamster.

There are hundreds of Teamsters Local Unions across North America. The local unions and their members are the heart and backbone of the union.

Unlike other labor unions, the Teamsters Union is structured to promote strong local unions, and strong local leaders. Since the locals negotiate most Teamsters contracts and provide most of the services to the members, they keep most of the dues money. Locals retain their own expert labor lawyers, certified public accountants, full-time business agents, organizers, and clerical staff.

The Members of each local elect their own officers, devise their own structure, and vote on their own bylaws, compatible with the International Constitution and Bylaws. While enjoying their independence, the locals benefit from the expertise and assistance of the International Union, and of the various conferences and councils in the union's structure.

Teamsters Joint Councils are set up in areas with three or more local unions. Joint Councils help coordinate Teamsters activities in those areas. They also help solve problems and decide some jurisdictional and judicial matters.

Teamster Trade Divisions and Conferences aid Teamster leaders throughout the country who share common interests and problems. They provide an informational clearinghouse for locals that negotiate in the same industry or bargain with the same employer.

The Teamsters were one of the first unions to establish a Safety and Health Department. The Safety and Health Department is committed to protecting the health and well-being of Teamster members, their families and their communities from chemical, biological, and physical health and safety hazards.

The IBT Safety and Health Department includes professionals in safety, industrial hygiene and adult education.

The Safety and Health Department provides many educational resources on line. Visit [www.teamster.org](http://www.teamster.org) and click on "Members", and then "Safety & Health."

---

The Teamsters offer safety and health training throughout the United States for:

- Construction Workers
- Hazardous Waste Workers
- Industrial Workers
- Hazardous Materials Transportation Workers
- Port Workers
- Emergency Responders
- Radiological Workers

## **Teamster Safety and Health Department**

## **Teamster Training**

## **Teamster Training Centers**

Teamster instructors use effective adult education, real equipment, and realistic hands-on activities.

Teamster instructors have experience doing the same types of jobs that trainees perform, including hazmat transportation, warehousing, construction and remediation. Instructors use participatory adult teaching techniques and hands-on activities. Instructors have completed the OSHA 500 and 501 Construction and General Industry Trainer Courses. Teamster instructors complete a period of supervised teaching and evaluation. Each instructor attends an annual Instructor Development Program that includes new regulations and work procedures, and practice teaching. Each Instructor is certified in first aid / CPR.

---

## **Teamster Instructors**

Teamster Training Centers have classrooms and outdoor areas for realistic hands-on activities. The Training Centers also have mobile units that can transport instructors and equipment to hold courses at hazardous waste sites, construction projects, company locations and union halls ... anywhere.

---

## **For More Information**

For more information, or to schedule a course, contact:

IBT Worker Training Program  
25 Louisiana Avenue, N.W.  
Washington, DC 20001  
(202) 624-6963  
(202) 624-8125 (fax)

[www.teamster.org](http://www.teamster.org)

- notes -

Module  
**1**

# OSHA

## Introduction to OSHA

### Learning objectives

This module introduces the OSHA standards that apply to construction work, and the rights and responsibilities of workers and employers with regard to occupational safety and health.

After completing this module you will be able to demonstrate your ability to:

1. DESCRIBE briefly the history and purpose of OSHA and the OSH Act.
2. IDENTIFY the safety and health rights and responsibilities of employers and employees.
3. IDENTIFY the rights of whistle-blowers.
4. DESCRIBE what to do if you feel that it is unsafe to do an assigned task.
5. IDENTIFY the basic OSHA record keeping requirements.
6. IDENTIFY the qualifications of a competent person.
7. EXPLAIN the General Duty Clause.
8. RECOGNIZE that there are resources available from OSHA through its web site and 800 number.

**OSHA** stands for the **Occupational Safety and Health Administration**. It is the federal agency that enforces safety and health standards to protect workers.

In 26 states there are state safety and health agencies that do this job instead of federal OSHA.

States that have their own Occupational Safety and Health Program		
Alaska	Michigan	South Carolina
Arizona	Minnesota	Tennessee
California	Nevada	Utah
Connecticut*	New Jersey*	Vermont
Hawaii	New Mexico	Virgin Islands*
Indiana	New York*	Virginia
Iowa	North Carolina	Washington
Kentucky	Oregon	Wyoming
Maryland	Puerto Rico	

\* The programs in CT, NJ, NY and VI only apply to public employees.

In 1970 Congress passed a law called the **Occupational Safety and Health Act**, or **OSH Act**. This law created OSHA, and gave OSHA the power to write safety and health standards.

---

In addition to creating OSHA, the OSH Act also created **NIOSH**, the **National Institute for Occupational Safety and Health**. This federal agency studies safety and health problems, recommends standards, and gives advice to workers and employers.

## OSHA and the OSH Act

## NIOSH

## **Purpose of the OSH Act**

The OSH Act says:

**The Congress declares its purpose and policy...to assure so far as possible every working man and woman in the Nation safe and healthful working conditions and to preserve our human resources...**

---

## **Responsibilities of Employers**

Section 5 of the OSH Act declares the responsibilities of employers with regard to safety and health:

### **Each employer -**

- (1) shall furnish to each of its employees employment and a place of employment which are free from recognized hazards that are causing or are likely to cause death or serious physical harm to its employees;
- (2) shall comply with the occupational safety and health standards promulgated under this Act.

Your employer has two responsibilities: (1) to provide you with safe and healthy work and a safe and healthy work place, and (2) to comply with OSHA standards.

---

## **General Duty Clause**

The first of these employer responsibilities is called the General Duty Clause. The General Duty Clause means that even if there is no OSHA Standard about a particular safety or health problem, the employer still has to make sure that your workplace is safe, healthy and free of recognized hazards.



Section 5 of the OSH Act also describes the duty of employees:

**Each employee shall comply with occupational safety and health standards and all rules, regulations, and orders issued pursuant to this Act which are applicable to his own actions and conduct.**

OSHA does not issue orders to workers. It does not fine workers. As an employee you are expected to comply with the instructions issued by your employer. These include following safe work practices and wearing personal protective equipment required by OSHA. If you fail to follow your supervisor's instructions you might be disciplined or terminated.

---

OSHA writes rules, called OSHA Standards, to protect workers on the job. There are many OSHA standards that may apply to your job. For example: standards which limit the concentration of toxic substances in workplace air, standards for the safe operation of forklifts, or standards for electrical safety.

**OSHA standards have the force of law.**

---

OSHA inspects work sites. OSHA can issue correction orders and assess penalties against the employer. You have the right to talk to the OSHA inspector, to point out hazards, and to see a copy of the inspection report.

## **Responsibilities of Employees**

### **OSHA Makes Rules**

### **OSHA Enforces Rules**

## Your OSHA Rights

OSHA requires your employer to:

- Provide a safe and healthy workplace.
- Comply with OSHA standards.

As an employee, you have legal rights, and you also have the responsibility to work in a safe manner in compliance with OSHA standards.

Your OSHA rights include:

1. The right to a safe and healthy workplace.
2. The right to receive safety and health training.
  - A. Hazard communication training.
  - B. HAZWOPER emergency response training.
  - C. Respirator training (if applicable).
  - D. Confined space training (if applicable).
3. The right to information.
  - A. Material Safety Data Sheets (MSDSs).
  - B. Your employer's Log of Work-Related Injuries and Illnesses (the OSHA 300 Log).
  - C. Results of workplace monitoring and surveys.
  - D. Your own medical records.
  - E. Your employer's written safety and health plans.
  - F. Copies of any OSHA citations.
4. The right to take part in safety and health activities.
  - A. Point out hazards and suggest corrections.
  - B. Discuss safety and health concerns with your fellow workers and your union representative.

5. The right to participate in OSHA inspections.
  - A. You or your union representative participate in the opening and closing conferences.
  - B. You or your union representative accompany the OSHA inspector during the inspection.
  - C. Respond to questions from the OSHA inspector.
6. The right to file an OSHA complaint if a hazard exists.
  - A. Have your name kept confidential by OSHA.
  - B. Be told by OSHA of actions on your complaint.
  - C. Be notified if your employer contests a citation.
  - D. Object to an abatement period proposed by OSHA.
7. The right to refuse to do work that would expose you to imminent danger of death or serious injury.

(See the next page for more detail about this right.)

8. Protection from retaliation or discrimination because of your safety and health activities.

File a discrimination complaint with OSHA if you have been discriminated against for discussing safety and health, pointing out hazards, filing an OSHA complaint, or refusing dangerous work.

If you file a complaint with OSHA, put it in writing, be specific, and cite the exact standard that's being violated. Keep a copy for your records. Be sure to also contact your union representative.

## Whistle-blower Rights

You have the right to file a complaint with OSHA because of safety and health hazards at your work site.

Section 11(c) of the OSH Act makes it illegal for the employer to discipline you for using your OSHA rights:

**No person shall discharge or in any manner discriminate against any employee because such employee has filed a complaint or ... because of the exercise ... of any right afforded by this Act.**

---

## The Right to Refuse Dangerous Work

What if a situation arises where you believe it is unsafe to do a task? For example, you are assigned a truck with faulty brakes. The union contract and the law give you rights if you feel that you must refuse to do dangerous work. To preserve your rights:

- 1. Don't act alone.** Talk with your fellow workers. If you are a union member, contact your shop steward or union representative.
- 2. Point out the danger** to the supervisor and to your fellow workers.
- 3. Be clear that you are not insubordinate.** Explain that you will do the job if it can be done safely.
- 4. Offer to do other work.**
- 5. Don't walk off the job.** Don't leave the site unless ordered to do so by the supervisor.

---

Usually you, or your union steward will be able to resolve the problem by discussing it with the supervisor.

---

If you are disciplined, your union representative can help you to file a grievance. You should also consider filing a complaint about your discipline with OSHA and with the National Labor Relations Board.

Many OSHA regulations require there to be a competent person who takes responsibility for inspecting or approving work or equipment. OSHA defines a competent person as:

**One who is capable of identifying existing and predictable hazards in the surroundings or working conditions which are unsanitary, hazardous, or dangerous to employees, and who has authorization to take prompt corrective measures to eliminate them.**

A competent person is someone who understands the work and its hazards, and has the authority to correct unsafe conditions.

---

OSHA requires your employer to keep records of the OSHA recordables - injuries and illnesses that result in:

- Death.
- One or more days away from work after the day on which the injury happened.
- Restricted work or transfer to another job.
- Medical treatment beyond first aid.
- Loss of consciousness.
- A significant injury or illness diagnosed by a doctor or other licensed health care professional.

You have a right to see any records about your own injury or illness. You also have the right to see the employer's OSHA 300 Log, which is a list of all the recordable accidents and injuries that occur in your work place each year. The employer must post the OSHA 300 Log for each year in a conspicuous place from February 1 to April 30 of the year following the year that the log describes.

## **Competent Person**

[29 CFR 1926.32(f)]

## **Record Keeping Requirements**

## Numbering System for OSHA Standards

---

The citation helps you find it in a law book, and it makes it easy to refer to a particular requirement.

---

Here is part of the OSHA Electrical Standard:

Ground-fault circuit interrupters. All 120-volt, single phase, 15- and 20-ampere receptacle outlets on construction sites, which are not part of the permanent wiring of the building or structure and which are in use by employees, shall have approved ground-fault circuit interrupters for personnel protection.

This paragraph has a number called a citation. The citation is 29 CFR 1926.404(b)(1)(ii). Every paragraph has its own citation.

- **CFR** stands for **Code of Federal Regulations**. This is a set of law books containing all the regulations of all the federal agencies.
- **29** is the number for the **US Department of Labor**. OSHA is part of the Department of Labor, so its citations start with **29**.
- **1926** is the part of the OSHA standards that apply to the **Construction Industry**.
- **404** is the Section of the Construction Industry Standards titled “Wiring design and protection.”
- **b** is the second topic in Section 404. In this case, **b** is called “branch circuits.”
- **1** is the first subtopic in **b**. It is called “Ground fault protection.”
- **ii** is the second item in part 1. It is called “Ground fault circuit interrupters.”

Part 1926, Construction Industry Standards, is divided into several Subparts. Each subpart has a different general topic and a different letter. For example: “Subpart K, Electrical”, “Subpart L, Scaffolding”, etc. Section 404 in the example above is in subpart K. However, the subpart letter, “K”, is not used in the citation.

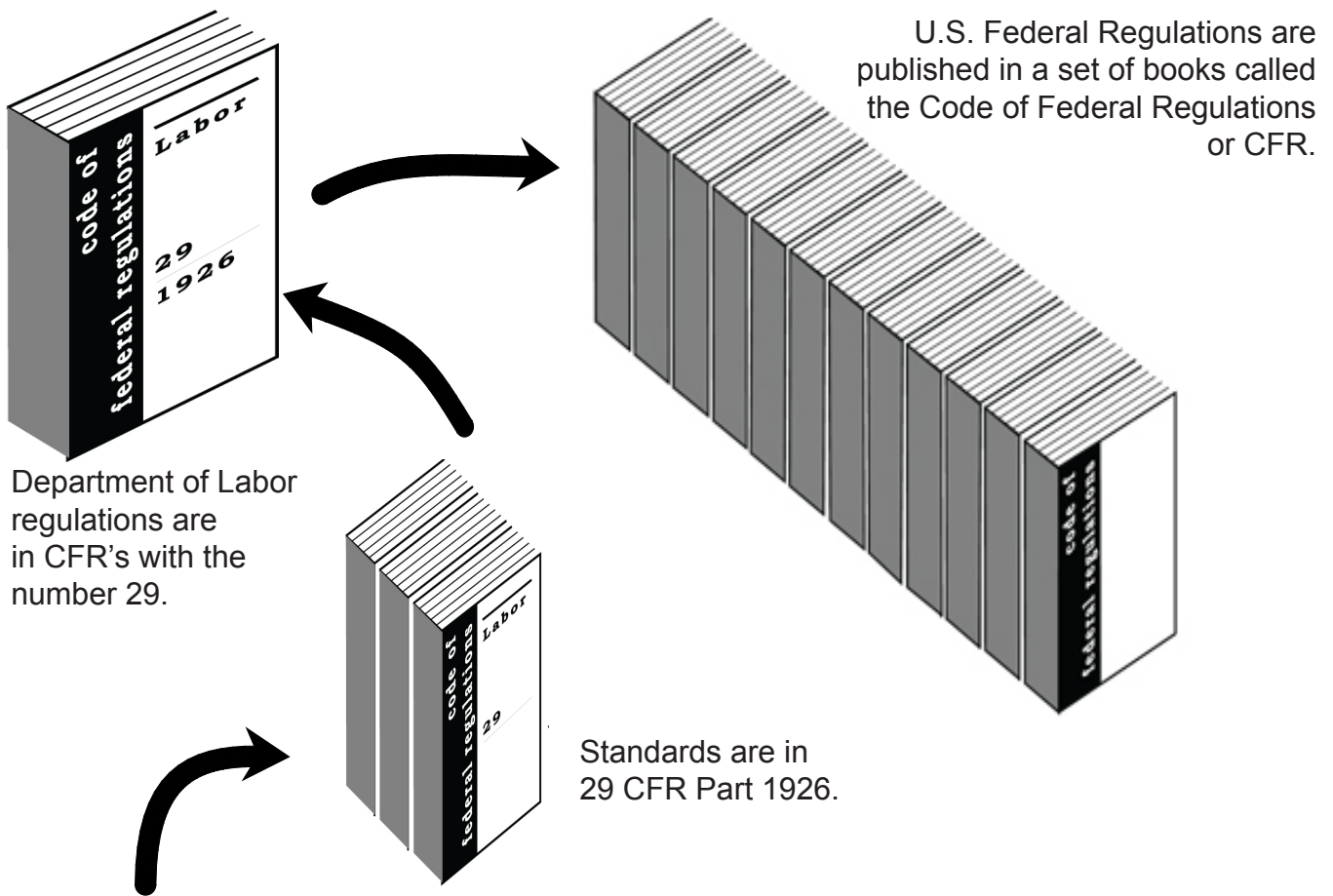

#### §404 Wiring design and protection.

(a) Use and identification of grounded and grounding conductors—

- (1) Identification of conductors ....
- (2) Polarity ....
- (3) Use of grounding ....

(b) Branch circuits—

(1) Ground-fault protection—

(i) General. The employer shall use either ground fault circuit interrupters as specified in paragraph (b)(1)(ii) of this section or an assured equipment grounding conductor program as specified in paragraph (b)(1)(iii) of this section to protect employees ....

(ii) Ground-fault circuit interrupters. All 120-volt, single-phase, 15- and 20- Ampere receptacle outlets on construction sites, which are not a part of the permanent wiring of the building or structure and which are in use by employees, shall have approved ground-fault circuit interrupters for personnel protection. Receptacles on a two-wire, single-phase portable or vehicle-mounted generator rated not more than 5kW, where the circuit conductors of the generator are insulated from the generator frame and all other grounded surfaces, need not be protected with ground-fault circuit interrupters.

## General OSHA Safety & Health Provisions

The OSHA Construction Standards contain several general safety and health requirements that apply to all construction sites and to all types of work at those sites.

**Contractor Requirements.** A contractor shall not require an employee to work in conditions that are unsanitary, hazardous or dangerous. [29 CFR 1926.20(a)]

**Accident Prevention.** A **competent person** must make frequent, regular inspections of the job site, materials and equipment, to look for safety and health hazards.

All machinery and tools must comply with OSHA standards. If it's not safe, it can't be used. Only properly trained or experienced workers shall operate machinery.

[29 CFR 1926.20(b)(3)]

**Safety Training.** The employer must instruct each employee to recognize and avoid unsafe conditions and how to avoid hazards.

Employees required to handle hazardous substances must receive instruction regarding safe use, potential hazards, and personal protective equipment. [29 CFR 1926.21(b)(3)]

Employees required to enter **confined spaces** must receive instruction on the nature of the hazards involved, precautions to take, protective equipment and emergency procedures. [29 CFR 1926.21(b)(6)]

**First Aid.** The employer must provide first aid services for every employee. [29 CFR 1926.23]

**Fire Protection and Prevention.** The employer must have a program for fire protection and prevention. This includes making sure that fire extinguishing equipment is available. [29 CFR 1926.24]

---

Your state might also require that there be one or more persons on the job certified in First Aid and CPR.

---



## General OSHA Safety & Health Provisions

**Housekeeping.** The employer must provide waste containers, and must remove combustible debris and scrap with protruding nails. [29 CFR 1926.25]

**Illumination.** The employer shall provide sufficient natural or artificial illumination for work areas, ramps, stairs, offices, shops and storage areas on the construction site. [29 CFR 1926.26]

**Sanitation.** The employer is responsible for providing adequate drinking water and sanitary facilities at construction sites. [29 CFR 1926.27]

**Personal Protective Equipment.** The employer shall provide necessary respirators and other protective equipment and require that it be worn when necessary. [29 CFR 1926.28]

**Access to Employee Medical Records.** As an employee you have a right to see and copy any medical records about you that your employer has. You also have the right to see and copy any records of exposures, such as air sampling results, that indicate the exposure that you might have experienced on the job. [29 CFR 1926.33]

**Escape Exits.** The building or structure under construction must have exits that allow escape from all areas at all times in case of emergency. (In the case of work at an occupied prison or mental hospital, doors can be locked provided supervisory personnel is continually on duty to facilitate emergency escape.) [29 CFR 1926.34]

---

You can authorize another person, such as your union representative or attorney to get these records for you.

---

## **1-800-321-OSHA**

If there is an emergency or if a hazard is immediately life-threatening, call your local OSHA Regional Office or 1-800-321-OSHA.

If you are in a state that has its own state program, and you do not know the phone number, call 1-800-321-OSHA, and they will direct you to your state office.

## **For More Information about Health and Safety**

---

The **IBT Safety and Health Department** has many fact sheets about safety and health. Go to the Teamsters web site [www.teamster.org](http://www.teamster.org) and click on "Resources" and then "On Safety and Health." Or call **(202) 624-6963**.

There are hundreds of internet sites with health and safety information. Here are just a few sites to help you get started. All have links to other useful sites.

- **U.S. Occupational Safety and Health Administration (OSHA):**  
[www.osha.gov](http://www.osha.gov)
- **National Institute of Occupational Safety and Health (NIOSH):**  
[www.cdc.gov/niosh](http://www.cdc.gov/niosh)
- **U.S. Department of Transportation (DOT):**  
[www.hazmat.dot.gov](http://www.hazmat.dot.gov)
- **New Jersey Department of Health:**  
[www.state.nj.us/health/eoh/rtkweb](http://www.state.nj.us/health/eoh/rtkweb)

If you work at a Department of Energy Facility, **DOE Order 440.1A** says that workers at DOE facilities can “decline to perform an assigned task because of a reasonable belief that, under the circumstances, the task poses an imminent risk of death or serious bodily harm to that individual, coupled with a reasonable belief that there is insufficient time to seek effective redress through the normal hazard reporting and abatement procedures.”

---

**Section 405** of the Surface Transportation Assistance Act protects drivers, mechanics, and freight handlers from discrimination or discharge for:

- Refusing to operate a vehicle if to do so would violate a safety regulation.
- Refusing to operate a vehicle if the employee has a reasonable apprehension of serious injury, or injury to the public, because of the unsafe condition of the equipment.
- Complaining or testifying about violations of vehicle safety requirements.

If you feel that you must refuse to operate the vehicle, make sure that you first ask your supervisor to correct the problem, or give you another, safe vehicle to use.

If you believe that you have been penalized for refusing to drive an unsafe vehicle, you can file a Section 405 complaint with OSHA. Any complaint must be filed within 180 days.

If you belong to a union, you should talk to your shop steward or union representative.

**For Workers at  
DOE Sites**

**For Drivers,  
Mechanics and  
Freight Handlers:  
Section 405**

Module

2

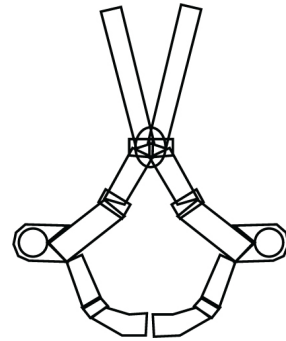

## Fall Protection

### Learning objectives

This module reviews the proper procedures and equipment for working safely at heights - in order to prevent falls.

After completing this module you will be able to demonstrate your ability to:

1. IDENTIFY the working surface height at which fall protection is required.
2. IDENTIFY the main components of a guardrail system.
3. IDENTIFY the main components of a safety net system.
4. EXPLAIN the main components of a personal fall arrest system.
5. DESCRIBE the requirements of a Fall Protection Training Program.

# Fall Protection Standard

[29 CFR 1926 Subpart M]

Scope, Application and Definitions  
29 CFR 1926.500

Duty to Have Fall Protection  
29 CFR 1926.501

- (a) General
- (b) (1) Unprotected Sides & Edges
- (b) (2) Leading Edges
- (b) (3) Hoist Areas
- (b) (4) Holes
- (b) (5) Form Work & Reinforcing
- (b) (6) Ramps, Runways, Walkways
- (b) (7) Excavations
- (b) (8) Dangerous Equipment
- (b) (9) Overhand Bricklaying
- (b) (10) Roofing & Low-sloped Roofs
- (b) (11) Steep Roofs
- (b) (12) Precast Concrete Erection
- (b) (13) Residential Construction
- (b) (14) Wall Openings
- (b) (15) Walking/working Surfaces
- (c) Protection from Falling Objects

Fall Protection Systems, Criteria and Practices  
29 CFR 1926.502

- (a) General
- (b) Guardrail Systems
- (c) Safety Net Systems
- (d) Personal Fall Arrest Systems
- (e) Positioning Device Systems
- (f) Warning Line Systems
- (g) Controlled Access Zones
- (h) Safety Monitoring Systems
- (i) Covers
- (j) Protection from Falling Objects
- (k) Fall Protection Plan

Training Requirements  
29 CFR 1926.503

- (a) Training Program
- (b) Certification of Training
- (c) Retraining

Five Non-Mandatory Appendices

- A Determining Roof Widths
- B Guardrail Systems
- C Personal Fall Arrest Systems
- D Positioning Device Systems
- E Sample Fall Protection Plan

# Fall Protection Standard

[29 CFR 1926 Subpart M]

Fall Protection is Subpart M of the OSHA Construction Standards. It has four sections and five non-mandatory appendices:

- Scope and Application and Definitions
- Duty to Have Fall Protection
- Fall Protection Systems, Criteria and Practices
- Training Requirements
- Five Non-Mandatory Appendices

The appendices show ways to comply with the Standard. Each appendix is “non-mandatory” (the employer doesn’t have to do exactly what the appendix says). The employer can use other methods as long as they get the same result.

---

# Falls Can Kill

Falls are the leading cause of construction worker fatalities. Each year, between 150 to 200 workers die and more than 100,000 are injured in falls.

The OSHA Standard covers certain construction site areas and construction activities.

Areas that require fall protection:

- Ramps
- Walkways
- Excavations
- Hoist areas
- Holes
- Form work and rebar
- Wall openings
- Unprotected sides and edges

Activities that require fall protection:

- Leading edge work
- Precast concrete erection
- Overhand bricklaying
- Residential construction
- Roofing work

---

OSHA requires construction employers to protect employees from fall hazards when they work 6 feet or more above a lower level. Some state programs require fall protection at five or even four feet.

---

The standard allows the employer to select the fall protection measures that are right for the type of work being done. These can include:

- Guardrail Systems
- Positioning Device Systems
- Safety Net Systems
- Warning Line Systems
- Personal Fall Arrest Systems
- Safety Monitoring Systems

## Scope and Application

---

Fall protection for workers on scaffolds is covered in Subpart L, Scaffolding.

---

## When You Work 6 Feet Up

## The Employer Chooses How to Do It

# Guardrail Systems

[29 CFR 1926.502(b)]

If the employer chooses to use guardrail systems to protect workers from falls, the systems must meet the following criteria:

The top rails and mid rails may be made of wire or rope which is at least one-quarter inch to prevent cuts and lacerations. If wire rope is used for top rails, it must be flagged at least every 6 feet with high-visibility material. If manila or synthetic rope is used, it must be inspected frequently to ensure strength and stability. Steel and plastic banding cannot be used as top rails or mid rails.

The top edge height of top rails must be between 39 inches and 45 inches above the walking level. If workers are using stilts, the top edge height must be increased an amount equal to the height of the stilts.

Screens or mesh can be used in place of mid rails. No opening in the guardrail system may be more than 19 inches across.

The guardrail system must be capable of withstanding a force of at least 200 pounds.

Guardrail components must be free of damage that could cause lacerations.

When guardrail systems are used at hoisting areas, a chain, gate or removable guardrail section must be placed across the access opening when hoisting operations are not taking place.

If guardrails are used on ramps and runways, they must be erected on each unprotected side or edge.



# Safety Net Systems

[29 CFR 1926.502(c)]

Safety nets must be installed close under the walking/working surface they protect and never more than 30 feet below that surface.

Safety nets must be inspected at least once a week for damage. Defective nets must not be used.

No opening in the net can be more than 36 inches square and no more than 6 inches on any side. The openings, measured center-to-center, of mesh ropes or webbing, must not be more than 6 inches.

Safety nets must have sufficient clearance underneath to prevent contact with the surface or structure below.

The potential fall area from the walking/working surface to the net shall be unobstructed.

Safety nets must extend outward from the outermost projection of the work surface as follows:

<b>How Far Out Nets Must Extend</b>	
Vertical distance from working level to the net	Minimum horizontal distance from the working surface to the outside of the net
Up to 5 feet.....	8 feet
5 feet to 10 feet .....	10 feet
More than 10 feet.....	13 feet

Safety nets shall be capable of absorbing an impact force of a 400-pound bag of sand 30 inches in diameter dropped from 42 inches above the highest surface on which employees work or walk.

Items that have fallen into safety nets must be removed as soon as possible and at least before the next shift.

## Personal Fall Arrest Systems

[29 CFR 1926.502(d)]

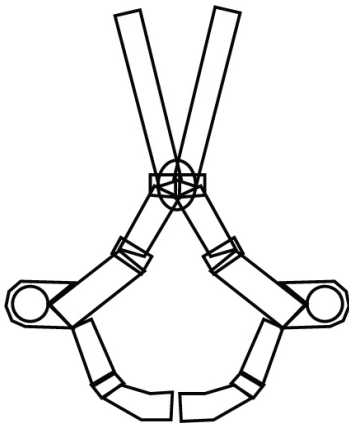

These consist of an anchorage, connectors, lifeline, lanyard, and a body harness. They may also include a deceleration device.

If a personal fall arrest system is used for fall protection, it must do the following:

- Limit maximum stopping force on an employee to 1,800 pounds.
- Not allow the employee to free fall more than 6 feet or hit a lower level.
- Bring an employee to a complete stop and limit maximum deceleration distance an employee travels to 3½ feet.
- Strong enough to withstand twice the impact of an employee free falling 6 feet or the free fall distance of the system, whichever is less.

The fall arrest system must include a body harness. Body belts were prohibited as of January 1, 1998. However, a body belt may still be used in a positioning device system.

Inspect the personal fall arrest system before each use for damage and deterioration. Remove defective components from service immediately.

Ropes and lanyards must be of synthetic fibers (like nylon and kevlar), not manila.

Snap hooks must be the locking kind, and must be designed for the object to which they are attached.

A competent person must supervise the design and installation of lifelines and anchorages.

A warning line system consist of ropes, wires, or chains, and supporting stanchions. The purpose of this system is not to physically prevent workers from falling, but to alert them to danger so they do not get too close to a fall hazard area. A warning line must be:

- Flagged at least once every 6 feet with high visibility material.
- All points must be between 34 and 39 inches above the walking surface.
- Posts that hold up the warning line must resist tipping by a moderate force of 16 pounds.
- The line must be rigged so that pulling on one section does not take up the slack in an adjacent section before the stanchion tips over.

Compare these requirements to the control line used in a controlled access zone. (See the next page.)

## **Warning Line Systems**

[29 CFR 1926.502(f)]

## Controlled Access Zones

[29 CFR 1926.502(g)]

A **controlled access zone** is an area where certain work (such as overhand bricklaying and leading edge work) may take place without the use of conventional fall protection systems. This is allowed because a fall protection system may interfere with the work and create a greater hazard.

**Control Line.** There must be a control line that defines the controlled access limits so that other workers don't enter. Control lines can be ropes, wires, or tapes with supporting stanchions. The control line must be:

- Flagged at least once every 6 feet with high visibility material.
- All points must be between 39 and 45 inches above the walking surface. It may be as high as 50 inches if overhand bricklaying is being done.
- Strong enough to sustain force of at least 200 pounds.
- Connected at each end to a wall or guardrail.
- A control line for a leading edge must be roughly parallel to the edge.

The Standard includes minimum and maximum distances for locating the control line from various activities.

When no other alternative fall protection can be implemented, the employer can appoint a competent person to monitor the safety of workers. This safety monitor must:

- Be competent to detect unsafe work practices and recognize fall hazards.
- Be located on the same walking/working surfaces of the workers and able to see them and communicate orally to warn them of fall hazards.
- Have no other duties to distract from the monitoring function.

---

A cover for a hole must be strong enough to support at least twice the weight of anybody or anything that might rest on it. For example, if the cover is on a hole in a roadway, then it must be able to support twice the axle load of the heaviest vehicle that might drive over it.

---

When guardrail systems are used to prevent materials from falling from one level to another, any openings must be small enough to prevent the passage of potential falling objects.

No materials or equipment except masonry and mortar shall be stored within 4 feet of working edges.

## **Safety Monitoring Systems**

[29 CFR 1926.502(h)]

## **Covers**

[29 CFR 1926.502(i)]

## **Protection from Falling Objects**

[29 CFR 1926.502(j)]

## **Toe Boards**

[29 CFR 1926.502(j)]

When toe boards are used as protection from falling objects, they must be erected along the edges of the overhead working surface for a distance sufficient to protect persons working below. Toe boards must:

- Be capable of withstanding a force of at least 50 pounds.
- Be at least 3½ inches tall.
- Have no more than ¼ inch clearance above the working surface and no gap or space greater than 1 inch along their length.

If tools or materials are piled higher than the top edge of a toe board, paneling or screening must be erected to protect employees below.

---

## **Canopies**

[29 CFR 1926.502(j)(8)]

When used as protection from falling objects, canopies must be strong enough to prevent collapse and to prevent penetration by any objects that fall on them.

---

## **Leading Edge Work**

[29 CFR 1926.501(b)(2)]

Each employee who is constructing a leading edge 6 feet or more above a lower level must be protected by a guardrail system, safety net system, or personal fall arrest system.

If the employer can demonstrate that it is infeasible or creates a greater hazard to implement these systems, the employer must implement a fall protection plan that will protect these workers.

Each employee in a hoist area must be protected from falling 6 feet or more by a guardrail system or personal fall arrest system.

If the guardrail (or part of it) must be removed to facilitate hoisting operations, as during the landing of materials, and a worker must lean through the access opening or over the edge of the opening to receive or guide materials, that employee must be protected by a personal fall arrest system.

---

If a hole is more than 6 feet deep, it must have a guardrail or a cover. However, if the work requires the hole to be open or the guardrail removed, then workers near the hole must use a personal fall arrest system.

A hole may not have more than two sides with removable guardrail sections.

---

OSHA does not require fall protection for employees while moving on the vertical face of rebar assemblies built in place.

OSHA considers the multiple hand holds and foot holds on rebar assemblies as providing similar protection as that provided by a fixed ladder. However, an employee must have fall protection when moving at a height more than 24 feet, the same as for fixed ladders.

## **Hoist Areas**

[29 CFR 1926.501(b)(3)]

## **Holes**

[29 CFR 1926.501(b)(4)]

## **Form Work and Rebar**

[29 CFR 1926.501(b)(5)]

## **Excavations**

[29 CFR 1926.501(b)(7)]

If an excavation is 6 feet deep, or more, then employees working near the excavation must be protected by a guardrail system, fence, barricade, or cover.

If there is a walkway to cross over the excavation, it must have a guardrail if it is 6 feet or more from the walkway to the lower level.

---

## **Ramps and Walkways**

[29 CFR 1926.501(b)(6)]

If a ramp, runway or walkway is more than 6 feet above the level below, it must have guardrails.

---

## **Overhand Brick Laying**

[29 CFR 1926.501(b)(9)]

Each employee performing overhand bricklaying or related work 6 feet or more above lower levels must be protected by a guardrail system, safety net system, or personal fall arrest system, or shall work in a controlled access zone.

If the job requires the employee to reach more than 10 inches below the surface on which they are working, then the employee must be protected by a guardrail system, safety net system, or personal fall arrest system.

---

## **Roofs**

[29 CFR 1926.501(b)(10-11)]

Sides and edges 6 feet or more above lower levels must have a guardrail system, safety net system, or personal fall arrest system.

On a low slope roof there can be a combination of a warning line system and guardrails, safety nets, personal fall arrest, or safety monitoring system. On low-slope roofs 50 feet or less in width, the use of a safety monitoring system without a warning line system is permitted.



Each employee who is erecting precast concrete members and related operations such as grouting 6 feet or more above a lower level must be protected by a guardrail system, safety net system, or personal fall arrest system.

If the employer can demonstrate that it is infeasible or creates a greater hazard to implement these systems, the employer must implement a fall protection plan that will protect these workers.

---

If the employer can demonstrate that it is infeasible or creates a greater hazard to implement a guardrail system, safety net system or personal fall arrest system, the employer must implement a fall protection plan that will protect these workers. Appendix M has alternative fall protection plans that may be used.

---

If a wall opening is less than 39 inches above a work surface on the inside of the opening and 6 feet or more above the lower level on the outside of the opening, then it must be guarded with a guardrail system, safety net system or personal fall arrest system.

## **Precast Concrete**

[29 CFR 1926.501(b)(12)]

## **Residential Construction**

[29 CFR 1926.501(b)(13)]

## **Wall Opening**

[29 CFR 1926.501(b)(14)]

## **Training Requirement**

[29 CFR 1926.503]

Employers must provide a training program for employees who might be exposed to fall hazards. The Fall Protection Training Program must include:

- The nature of fall hazards in the work area.
- The correct procedures for erecting, maintaining, disassembling, and inspecting fall protection systems.
- The use and operation of controlled access zones and guardrail, personal fall arrest, safety net, warning line, and safety monitoring systems.
- The role of each employee in the safety monitoring system when the system is in use.
- The limitations on the use of mechanical equipment during the performance of roofing work on low-slope roofs.
- The correct procedures for equipment and materials handling and storage and the erection of overhead protection.
- Employees' role in fall protection plans
- The standards in Subpart M.

Employers must prepare a written certification that identifies the employees trained and the date of the training. The employer or trainer must sign the certification record. Retraining also must be provided when necessary.

- notes -

Module

3



## Electrical Safety

### Learning objectives

This module describes the hazards created by electric installations, wiring and equipment at construction sites, and reviews the safe work practices that will reduce the risk of electrocution and other injuries or damage.

After completing this module you will be able to demonstrate your ability to:

1. IDENTIFY five safety requirements for electrical installations that supply power and lighting at construction sites.
2. IDENTIFY five requirements of an assured equipment grounding conductor program if the employer chooses this option.
3. IDENTIFY where GFCIs shall be used if the employer chooses the GFCI option.
4. IDENTIFY five safe work practices to protect construction workers from electrical hazards.
5. IDENTIFY four preventive measures to prevent heat stress.
6. IDENTIFY four safety requirements for areas where batteries are stored.

The Electrical Standard is Subpart K of the OSHA Construction Standard. It has 14 sections, as shown in the boxes below.

# Electrical Standard

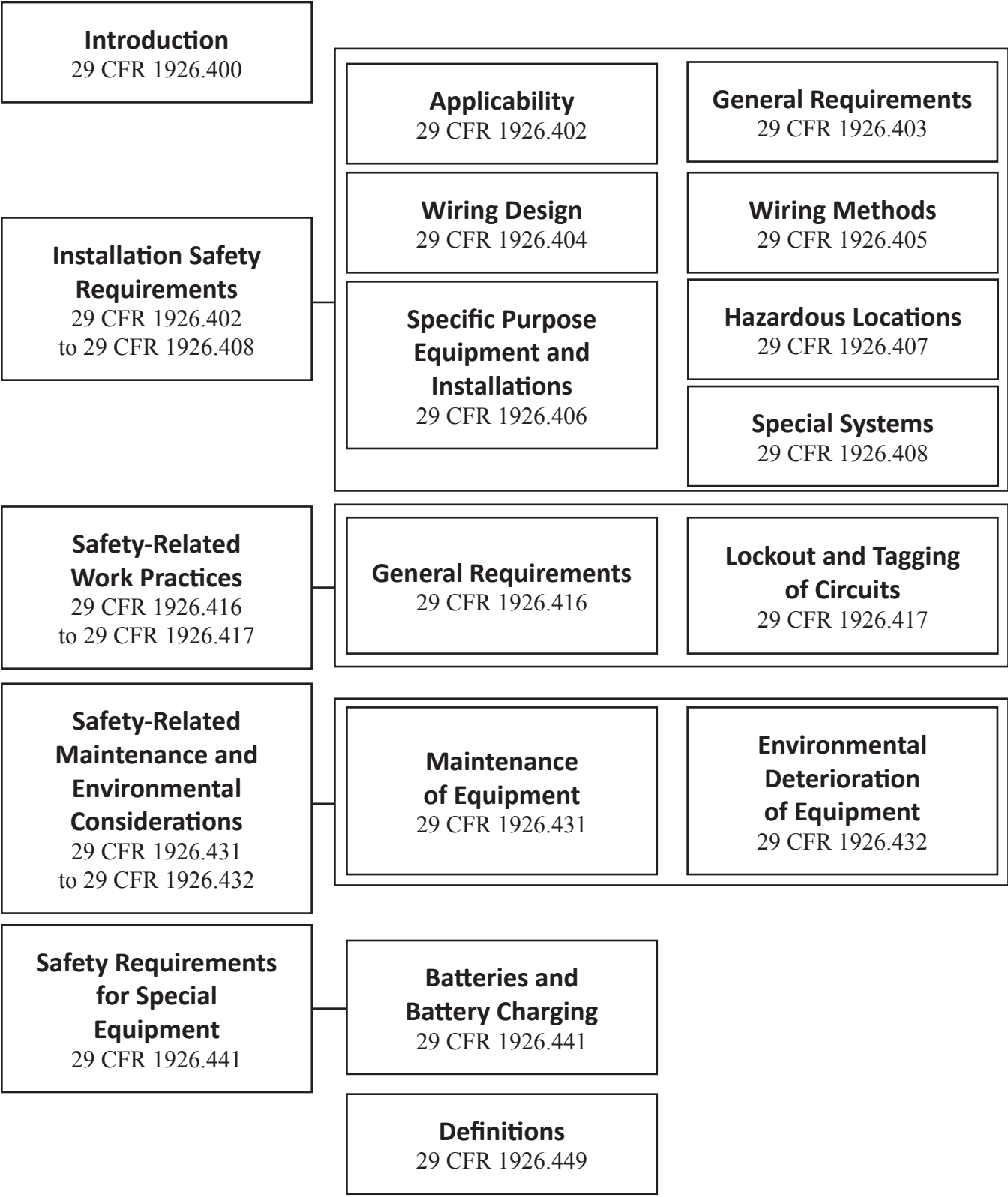

## Electrical Hazards

Electricity creates two main hazards at construction sites.

### **(1) Shock or electrocution.**

If you come in contact with a live circuit you may be shocked, burned or killed. Even if the shock itself doesn't cause injury, it might make you have an accident like falling from a ladder.

When you turn a switch on or off, or connect or disconnect a cord, there might be a spark which could ignite flammable gasses, vapors or dust in the air. Equipment such as a motor creates sparks as it operates.

In order to prevent shock or electrocution, OSHA has requirements for electrical installations, maintenance of equipment and safe work practices. The purpose is to keep workers from accidentally contacting live wires or parts.

There is also a provision for ground fault circuit interrupters (GFCI) which in many situations can save your life even if you do come in contact with a live circuit.

### **(2) Fire or explosion.**

If too much current flows through a wire or a piece of equipment it might get hot enough to start a fire.

When you turn a switch on or off, or connect or disconnect a cord, there might be a spark which could ignite flammable gasses, vapors or dust in the air. Equipment such as a motor creates sparks as it operates.

In order to prevent fire and explosion, OSHA has requirements for special wiring and equipment in areas where flammable materials may be present in the air.



## **Applicability of the Standard**

The OSHA Electrical Standard applies to temporary and permanent installations on the job site, but does not apply to permanent installations that were in place before the job began.

---

## **Approved Equipment**

All electrical conductors and equipment must be approved by a nationally recognized testing organization such as UL. For example, this includes extension cords, service panels, switches and breakers.

---

## **Marking**

[29 CFR 1926.403(g)]

Electrical equipment must have a label that tells the manufacturer and the electrical rating (voltage, amps and watts).

This requirement also applies to extension cords made on the job. They must have a label.

---

## **Extension Cords Made on the Job**

Extension cords made on the job are acceptable provided they are assembled by a qualified person in a manner equivalent to cords that are factory-assembled and approved. All components must be approved, and must be compatible with the other components. Boxes intended for permanent installations may not be used in extension cords.



The employer shall make sure that electrical equipment is free from recognized hazards. To assure safety the employer shall consider:

- **Suitability.** Is this the right equipment for this purpose?
- **Strength and durability.** Will it provide protection? Will it last?
- **Insulation.** Is the insulation on tools and extension cords in good condition?
- **Heating effects.** Can the equipment cause overheating?
- **Arcing and sparks.** Can arcing and sparks occur where flammable materials are present?
- **Classification.** Is the equipment the right type, size, voltage, and current capacity for the job?
- **Other factors.** Any other factors that affect workers' safety.

---

All disconnecting switches must be clearly identified. You need to know how to turn it off in an emergency. The "OFF" switch on a machine, or the circuit disconnect shall have a label, unless it's location makes it obvious.

## Installation and Use of Electrical Equipment

[29 CFR 1926.403(b)]

## Identification of Disconnecting Means

[29 CFR 1926.403(h)]

## Guarding of Live Parts

[29 CFR 1926.403(i)(2)]

Live parts of electrical equipment operating at 50 volts or greater shall be guarded so that workers cannot accidentally come into contact with them. Here are some ways to achieve safe guarding:

- **Cabinet, room or vault.** Only accessible to qualified persons.
- **Partitions.** Strong, permanent partitions to exclude unqualified persons.
- **Platform.** On a balcony or platform that excludes unqualified persons.
- **Elevate.** Place on a pole or elevated location at least 8 feet up.

## Overcurrent Protection

[29 CFR 1926.404(e)]

Too much current can cause wires and equipment to overheat. Protection from overcurrent means:

- Large enough conductors. Wires must be large enough to handle the load that they are expected to carry.
- Each circuit shall have a proper fuse or circuit breaker.
- No fuse on the grounded conductor. The grounded (green) wire must stay connected. It should not have a fuse or circuit breaker.
- Locate fuses and circuit breakers properly. Fuses or circuit breakers shall be in a location that is easy and safe to get at, and where there are no flammable or combustible materials stored.

A wire can only handle a certain amount of electricity. If too many tools are connected (or too big a tool), then too much electricity will try to flow. The wire will overheat, possibly starting a fire. A circuit breaker (or fuse) disconnects the circuit if more than a specific current tries to pass. This protects equipment and property, but does not necessarily protect you from shock or electrocution.

---

If the wiring inside a tool becomes frayed, and touches the tool's metal case, then electricity can pass into the hand of the person holding the tool. If the person is also in contact with something that conducts electricity (like damp ground), then some electricity will pass through the person's body.

The green ground wire in a tool's cord is attached to the tool's metal case. This wire is supposed to be connected, via the third prong, to a wire that returns to the service box. The idea is for the ground wire to provide such a good path that the electricity will take this route, rather than through the body. This easy path should also allow so much current to flow that the circuit breaker or fuse trips. This only works if the ground wire is in good condition and properly connected all the way back to the service box.

You have heard that "electricity takes the path of least resistance." This isn't exactly correct. Faced with two possible paths, most, but not all, takes the easy path. Most current will return via the ground wire, but a little might still pass through the person's body. If the ground circuit is not in good condition, then even more electricity will pass through the person. It might be enough to kill!

## Circuit Breakers and Fuses

---

Breakers and fuses protect equipment and property, but do not necessarily protect you from shock or electrocution.

---

## Grounded Circuits (Third Wire)

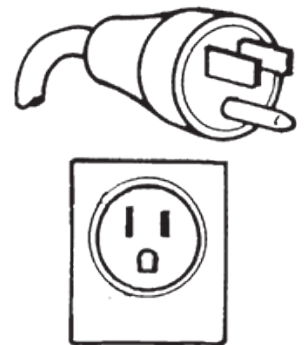

---

Most of the current will take the path of least resistance, but a little bit might still pass through your body.

---

## **Grounding Equipment Connected by Plug and Cord**

[29 CFR 1926.404(f)(7)(iv)]

Exposed noncurrent-carrying metal parts of corded tools and equipment must be grounded. This requirement applies to:

- Hand-held motor operated tools.
- Equipment used in damp or wet locations.
- Equipment used by workers standing on the bare ground, on metal floors, or inside a metal tank.
- Portable x-ray equipment.
- Portable hand lamps.

Exception: A double insulated tool doesn't have to be grounded.

---

## **Double Insulated Tools**

Some hand tools don't have a third wire ground, but they do have a plastic case that doesn't conduct electricity. The plastic case is intended to prevent injury, as long as it's not broken.

**Ground Fault Circuit Interrupter (GFCI).** Electricity moves in a circle, down the black wire, through the tool, and back on the white wire. The tool does not use up the current. The same amount of current leaves the tool as enters it. Under normal conditions, the same current flows through each of the two wires. If there is damage, then some current might return via the green ground wire – or through your body.

A Ground Fault Circuit Interrupter (GFCI) senses flow in the black and white wires. If it's not the same, the GFCI shuts off the circuit. If some current is flowing through your body, the GFCI will sense less current in the white wire. The GFCI will trip before your heart does. A GFCI can sense a difference as small as 5 milliampere, and can shut off in a fraction of a second, before there's enough current to cause ventricular fibrillation.

OSHA requires construction sites to have either an assured grounding program or use GFCI's. An "assured grounding program" means that the ground wires are checked at least daily.[29 CFR 1946.404(b)(1)(iii)]

However, something could happen between checks. So, GFCI's provide better protection against electrocution.

The best protection is a combination of all three:

1. A circuit breaker (or fuse) to protect against fire caused by overheated circuits,
2. A grounded third-wire to provide additional fire protection and some protection against electrocution, and
3. A GFCI for the best protection against current that is enough to kill but too small to blow the breaker.



---

We have described what happens if your body acts as a path for some of the current. However, if you contact both regular wires, you are part of the regular circuit. Equal current will still flow through both of the wires. The GFCI won't notice. No device can protect you in this case.

---

# Assured Equipment Grounding Conductor Program

[29 CFR 1926.404(b)(1)(iii)]

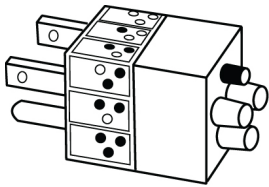

---

## Test Schedule

- Before each piece of equipment is used for the first time.
  - At least once every three months.
- 

The grounding conductor — the green wire — normally doesn't carry current. However, if there is a ground fault, then the ground wire is supposed to provide an easy path for the fault current to go to ground.

This only works if the ground conductors have continuity, which means that the ground connection has to be complete through all cords, plugs, receptacles and wiring — all the way back to the service panel.

To ensure that the ground conductors are in good working order, OSHA requires the employer to develop an Assured Equipment Grounding Conductor Program. This program must include:

- **A written description of the program** that includes all procedures, tests and the test schedule.
- **One or more competent persons** who inspect and test the ground connections and make records of the tests.
- **No damaged or defective equipment should be used.**
- **Visual inspections every day.** Visually inspect cords, plugs, and tools for defects and damage before each day's use.
- **Continuity test.** Test the continuity of the ground conductor on cord sets, grounded tools and equipment, and receptacles. Use a lamp and battery, ohmmeter or a receptacle tester.
- **Proper terminal test.** Use a receptacle tester to assure that the ground at each receptacle is connected to the correct terminal.

Cranes and other equipment must maintain a sufficient clearance from overhead power lines.

The minimum distance from any power line is 10 feet. A greater distance is required for lines carrying more than 50 kilovolts. [29 CFR 1926.550(a)(15)]

A Teamster operating a boom truck is focused on picking and placing the load, and can lose track of how close the boom is getting to a power line. Use a spotter when working near power lines. The spotter can make the difference between a safe job and a potential fatality.

Always assume that any overhead line is energized, unless the owner or the utility has certified that it is not energized – and you can see that it's grounded.

Before any digging or excavation takes place, the contractor must locate all underground power lines, gas lines, communications cables, pipe lines and sewers. Contact utility companies for information. All lines should be marked, and, if possible, disconnected.

## Overhead and Underground Utilities

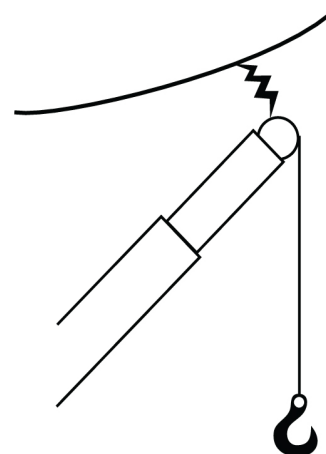

---

The minimum clearance is 10 feet.

---

## **Environmental Considerations**

[29 CFR 1926.432]

Some environmental conditions can damage wires and equipment. In the following situations, only use wire and equipment that is approved for that situation:

- Wet or damp locations.
- Where gases, vapors, fumes, liquids or other agents might cause deterioration of conductors or other equipment.
- High temperatures.

Equipment and wiring that is approved only for dry locations — and will be protected when the building is finished — shall be protected from the weather during construction.

---

## **Locations with Fire and Explosion Hazards**

[29 CFR 1926.407]

OSHA has special requirements intended to assure that wiring and equipment cannot cause gases, vapors, dusts, or fibers in the air to ignite or explode.

Some of the methods discussed in the OSHA Standard include:

- Thermal insulation so that hot equipment doesn't start a fire.
- Gaskets to prevent gases and vapors from contacting sparks.
- "Flame paths" designed into equipment so that if gases and vapors do get inside and cause an explosion, it will be contained in the device and the combustion products will cool before they escape.



There are special requirements for locations where unsealed batteries — for example, lead-acid type batteries — are used. The purpose of these requirements is to prevent the accumulation of explosive gas released from batteries, and to protect workers and equipment from exposure to the corrosive electrolytes in batteries.

- Locate batteries where gases, fumes and electrolytes cannot contaminate other areas or equipment.
- Ventilate so that gas does not accumulate into an explosive mixture.
- Use racks and trays that are acid resistant.
- Provide acid resistant floors.
- Provide face shields, aprons and rubber gloves to workers who handle batteries.
- Provide an emergency shower and eyewash station.
- Provide facilities for washing and neutralizing spilled electrolyte and for fire protection.

---

Safety requirements for charging batteries:

- Only charge batteries in a location designed for that purpose.
- Protect charging equipment from damage by trucks.
- Keep vent caps in place during charging.

## **Battery Use**

[29 CFR 1926.441(a)]

## **Battery Charging**

[29 CFR 1926.441(b)]

Module

4

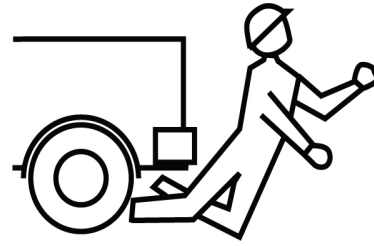

## Struck-By and Caught-In Hazards

### Learning objectives

This module reviews the risk of struck-by and caught-in accidents, and how to prevent them.

After completing this module you will be able to demonstrate your ability to:

1. IDENTIFY examples of struck-by and caught-in hazards.
2. IDENTIFY safe work practices that will reduce the possibility of struck-by and caught-in accidents.
3. EXPLAIN the importance of wearing a hard hat to prevent injuries caused by falling objects.

Being struck-by something or being caught-in between objects are two of the most common types of accidents at construction sites, and are leading causes of construction fatalities.

It is important that you are aware of the hazards at your work site, and that your employer promote safe work practices that reduce - as far as possible - the situations that can cause struck-by and caught-in accidents.

Examples of struck-by and caught-in accidents include:

- Severely injured by a falling tool or brick - because you are not wearing a hard hat.
- Crushed beneath a vehicle that tips over on soft ground.
- Struck by a backing vehicle.
- Struck by the bucket of a back-hoe as it swings.
- Pinned between a vehicle and a concrete wall.
- Caught between the turning platform and the frame of a crane.
- Hit by an automobile while working along a highway.

---

The contractor responsible for the site must establish a traffic management plan and make sure that all drivers and operators know:

- Which roadways and grades are acceptable for their type, size and weight of vehicles.
- Speed limits.
- Direction of traffic flow.

## **Struck-by and Caught-in Accidents**

## **Traffic Management Plan**

## Drivers and Operators

Drivers and operators must follow safe work practices to reduce struck-by and caught in accidents:

- Do a complete pre-job inspection of your vehicle. Be sure to check the brakes and the backup alarm.
- Drive only on roadways or grades designated for the kind of vehicle you are operating.
- Do not speed.
- Drive in reverse only if:
  - The vehicle has an audible reverse alarm, or
  - A spotter or flagger signals that it is safe.
- Make sure that all other personnel are in the clear before dumping.
- Lower or block the blade, bucket, or dump body when not in use. Leave all controls in neutral.
- Set parking brakes when vehicles and equipment are parked. Chock the wheels if on an incline.
- Don't exceed a vehicle's rated load or lift capacity.
- Use extreme caution on slopes or near excavations.
- Stay in your vehicle until it has come to a complete stop.
- Dump trucks must have a cab shield or canopy to protect the driver from falling materials, or the driver must leave the cab during loading.
- Make sure that your equipment has necessary rollover protection.

Many workers are injured or killed on construction sites when they are struck by a vehicle or other construction equipment, or caught between a vehicle and another object. Remember to:

- Stay alert.
- Wear your high-visibility vest or jacket.
- Listen for - and pay attention to - back-up alarms.
- Stay well clear of equipment that is loading or being loaded, or is dumping.
- On highway jobs, do not walk in active travel lanes.
- Beware of rotating equipment — watch for loose clothing.

## **Working around Vehicles and Heavy Equipment**

## Falling Objects

You are at risk from falling objects when you are beneath cranes, scaffolds, etc., or anywhere that work is being performed above you.

Follow these safe work practices:

- Wear a hard hat.
- Make sure that the scaffold has toe boards.
- Install debris nets where appropriate.
- Stack materials to prevent sliding, falling, or collapse.
- Don't work or walk beneath loads being moved by cranes and hoists.
- Inspect cranes and hoists to see that all components, such as wire rope, lifting hooks, chains, etc., are in good condition.
- Do not exceed the lifting capacity of cranes and hoists.
- Secure tools and materials to prevent them from falling on people below.
- Barricade hazard areas and post warning signs.

## Flying Objects

There is a danger from flying objects when power tools, or activities like pushing, pulling, or prying, may cause objects to become airborne. Injuries can range from minor abrasions to concussions, blindness, or death.

Follow these safe work practices:

- Wear a hard hat.
- Use safety glasses, goggles, face shields, etc., where machines or tools may cause flying particles.
- Inspect tools, such as saws and lathes, to insure that protective guards are in good condition.
- Make sure you are trained in the proper operation of powder actuated tools.
- Reduce compressed air used for cleaning to 30 psi, and only use with appropriate guarding and protective equipment.
- Never clean clothing with compressed air.

## Concrete and Masonry Walls

Constructing concrete and masonry walls is especially dangerous because of the tremendous loads that need to be supported. There are risks of major accidents, and even death, when jacks or lifting equipment are used to position slabs and walls, or when shoring is required until structures can support themselves.

Follow these safe work practices:

- Do not place construction loads on a concrete structure until a qualified person indicates that it can support the load.
- Adequately shore or brace structures until permanent supporting elements are in place, or concrete has been tested to assure sufficient strength.
- Only allow those who are essential to and actively engaged in construction or lifting operations to enter the work area.
- Take measures to prevent unrolled wire mesh from recoiling, such as securing each end or turning the roll over.
- Do not load lifting devices beyond their capacity.
- Use automatic holding devices to support forms in case a lifting mechanism fails.



- notes -

Module

5

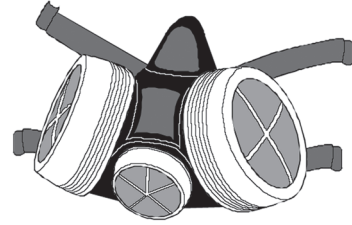

## Personal Protective Equipment

### Learning objectives

This module reviews the OSHA requirements for the safe and effective use of personal protective equipment, including work boots, hard hats, face shields and respirators.

After completing this module you will be able to demonstrate your ability to:

1. DESCRIBE how to inspect your hard hat.
2. IDENTIFY the two main types of respirators.
3. EXPLAIN the importance of making sure that your respirator fits correctly.
4. IDENTIFY the factors to consider in order to select the correct type of respirator and the correct cartridges or filters for that respirator.
5. EXPLAIN the importance of using the correct shade lens when welding or cutting.
6. EXPLAIN who pays for personal protective equipment that is necessary to work safely on a construction site.

**Personal Protective Equipment** or **PPE** includes glasses, face shields and goggles for eye and face protection, hard hats, gloves, boots, protective clothing and respirators. OSHA requires that you use personal protective equipment whenever it is necessary to protect you from injury including overexposure to contaminants.

There are design standards that the manufacturers of PPE must follow to make sure that the PPE works, and works safely. OSHA does not write the design standards, but it does require that PPE comply with design standards from other organizations such as ANSI and ASTM. Respirators must not only meet the NIOSH design standards, they must be submitted to a NIOSH approved laboratory for testing and certification.

---

There are many different kinds of safety shoes and safety boots. Most have a steel cup in the toe end to protect your toes from being crushed. They also usually have a steel shank in the sole to prevent punctures from nails. Some boots have an additional metatarsal protector further up to prevent the middle part of the foot from being crushed. There are also chemical resistant boots, electrically non-conductive boots, and other specialty footwear.

OSHA requires that safety shoes and boots comply with industry design standards written by ANSI or ASTM. Look at the label inside the tongue. It must say which standard it complies with.

(Note, the OSHA standard just mentions ANSI, but, in fact ASTM has taken over the design standards for shoes and boots.)

## **Personal Protective Equipment (PPE)**

## **Safety Shoes and Boots** [29 CFR 1926.96]

## Hard Hats

[29 CFR 1926.100]

OSHA requires workers to wear hard hats on a construction site wherever there is a possible danger of head injury from impact or flying objects, or if there is the possibility of electrical shocks and burns.

All hard hats must comply with ANSI standards. ANSI has standards for two types of hard hats:

- **Type I** - Protects against impact on the top.
- **Type II** - Protects against top and side impact.

Each type of hard hat is available in three different electrical conductivity classes:

- **Class G - General** (for most construction work.)
- **Class E - Electrical** (for work around exposed electrical conductors and equipment.)
- **Class C - Conductive** (for areas where it is critical to prevent static charges from building up.)

Bump caps, motorcycle helmets and bicycle helmets do not meet ANSI standards for hard hats, and may not be used on construction sites for head protection.

Eye and face protective equipment include safety glasses, goggles, and face shields. There are many types, and you must use the type that is appropriate for the work that you are doing.

OSHA requires workers to wear eye and face protection whenever there is the possibility of eye or face injury from flying objects (including dust, shavings and splinters), chemical splashes or radiation.

All eye and face protective equipment must comply with ANSI standards. Read the label to make sure that it does.

If you need corrective lenses, then you can use safety glasses that have your prescription ground in, or safety goggles that fit over your regular glasses. However, you must never wear regular glasses with a respirator, because the arms of the glasses will prevent the respirator from sealing against your face.

---

Welding and cutting produce both heat and intensely bright light that can quickly damage your eyes. Sometimes the damage is permanent. Some of this light you can't see (infra red and ultra violet) but it can still severely damage your eyes.

You must make sure that you have lenses that are dark enough to block out the dangerous rays - including the ones that you can't see.

Lenses come in different shade numbers. The higher the number, the darker the lens - and the more harmful rays it blocks out. The correct shade number depends on the type of welding or cutting, and in the case of electric arc welding, the amperage.

## **Eye and Face Protection**

[29 CFR 1926.102(a)]

## **Welding Shades**

[29 CFR 1926.102(b)]

# Air Contaminants

For something to be an air contaminant, it must be small enough to stay in the air and small enough to be inhaled. There are two ways that this can happen:

1. Gases and Vapors. These are individual molecules that become part of the air itself.
2. Particulates. These are tiny pieces that float in the air. Solid particulates: dust, fiber and fume. Liquid particulates: mist and spray.

## Oxygen Deficiency

Oxygen deficiency can occur in confined spaces where the oxygen has been used up, and there is poor ventilation so it doesn't get replaced. In fact, oxygen deficiency is the leading cause of confined space deaths.

19½% oxygen is the lowest level OSHA allows.

Below 19½% you must have a respirator that supplies breathing air.

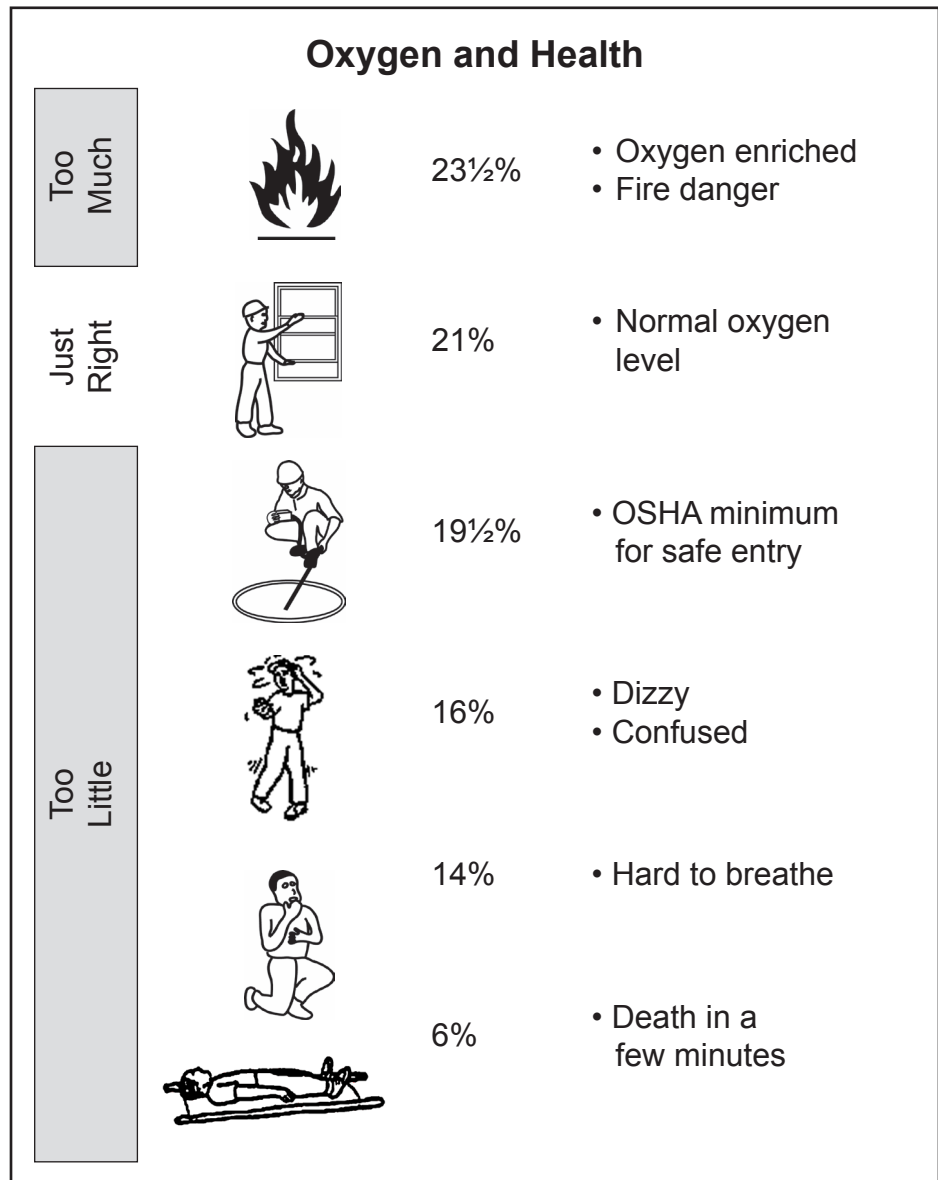

OSHA requires workers to wear respirators when there is no other way to prevent harmful exposure to air contaminants, while engineering controls are being installed or repaired, or when emergencies or other temporary situations arise. The OSHA respirator standard for construction is identical to the general industry standard.

---

These are three hazardous conditions in the air that require workers to use respirators:

1. Gas and vapor contaminants. These are individual molecules that become part of the air itself.
2. Particulate contaminants. These are tiny pieces that float in the air. Solid particulates: dust, fiber and fume. Liquid particulates: mist and spray.
3. Oxygen deficiency. The lowest level you are allowed to breathe is 19½%.

You may have all three conditions at the same time.

---

There are two basic types of respirators:

1. **Air Purifying Respirators (APR's)**. You breathe the dirty air around you. The respirator has filters or cartridges that try to clean that air before you inhale it. APR's do not supply oxygen.
2. **Atmosphere supplying respirators**. These have a separate, clean air supply from a cylinder on your back (SCBA), or an air line.

In an oxygen deficient atmosphere you must have an atmosphere supplying respirator.

## Respiratory Protection

[29 CFR 1926.103 - 29 CFR 1910.134]

### When Do You Need a Respirator?

### Types of Respirators



## Use the Correct Respirator

Respirators are serious equipment. There are different kinds of respirators - for different situations. You need to know how to select and use the proper respirator.

If you use the wrong respirator, you could be exposed to toxic chemicals or oxygen deficiency. It could even be fatal!

---

## NIOSH Approval

---

TC means: Tested & Certified.

---

NIOSH has standards for approving respirators.

- Never use a respirator or cartridge unless it has the NIOSH TC number and the NIOSH symbol.
  - Never try to use filters, valves or parts from one make of respirator on another make.
- 

## Air Purifying Respirators (APRs)

With an **Air Purifying Respirator** or **APR**, the air you breathe is the air around you. It starts out contaminated, and you depend on the filters or cartridges to catch the contaminants before you breathe them in.

There are many chemicals for which there is no filter or cartridge that works.

Air purifying respirators do not supply oxygen.

---

## Fit Testing

If the respirator doesn't fit your face almost perfectly, dirty air will get in around the edge of the respirator.

Before wearing any respirator that requires a tight seal against your face, you must have a fit test to make sure that the respirator fits you correctly.



The word dust mask can refer to two different things. One is a NIOSH approved respirator, and the other is not. You need to know the difference. A dust mask that is not NIOSH approved provides no protection against air contaminants. You are just fooling yourself if you think that it does.

Dust mask type respirators that are NIOSH approved have a technical name: filtering face piece respirator. The material the mask is made of acts as the filter.

Dust mask type respirators are filters. They only work for particulates in the air. **Dust masks provide no protection against gas or vapor contaminants.**

Some dust masks have an exhalation valve. This helps prevent the mask from soaking up moisture from the air you breathe out.

NIOSH approved dust masks have a rating of 95. This means that mask will clean at least 95% of the particles out of the air as it passes through the mask.

All NIOSH approved dust mask type respirators have two separate straps. This helps to make the mask fit against your face. Never use the kind that has only one rubber band; it won't seal well against your face - and it's not NIOSH approved.

Remember that a dust mask that is not NIOSH approved provides no protection against air contaminants. The material it's made of doesn't collect enough of the contaminants, and if it only has one strap, it won't seal well against your face. It may be cheap, but you are just fooling yourself if you think that it makes your work safer.

## Dust Mask Type Respirators



## Respirators with Replaceable Filters and Cartridges

---

If you are exposed to gases/vapors and particulates at the same time, then you need to use a combination filter-chemical cartridge.

---

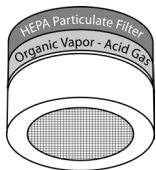

Some air purifying respirators use filters or cartridges:

- **Filters are for particulates.**

Particulates are small solid or liquid pieces floating in the air. A filter traps these particulates.

**Filters do not trap gases and vapors.**

- **Chemical cartridges are for gases and vapors.**

Gases and vapors are individual molecules in the air. Chemical cartridges catch some kinds of gases and vapors, but there are many gases and vapors for which there is no cartridge that works.

**Chemical cartridges do not protect against particulates.**

One of the most common mistakes that people make is to not understand the difference between a filter and a chemical cartridge. If you are exposed to particulates, use a filter. If you are exposed to gases or vapors, use a chemical cartridge.

OSHA says that for filters, you can use them until you sense increased breathing resistance, which means that the filters are getting clogged.

Breathing resistance does not increase when a chemical cartridge gets used up. For chemical cartridges, OSHA requires the employer to use a **change-out schedule** that is based on the concentration of contaminant in the air and on how hard you are working. This has to be determined by a person with technical expertise.

OSHA also allows you to use a chemical cartridge that has an **End of Service Life Indicator (ESLI)**. This is something that changes color when the cartridge is full. However, there are very few of this kind of cartridge available.

---

**IDLH** means **Immediately Dangerous to Life and Health**. If you are exposed to an IDLH concentration (or greater) for thirty minutes or more, you will likely:

- Die, or
- Suffer permanent damage to your health, or
- Become unconscious or otherwise unable to leave the area (after which you might die, or suffer permanent damage to your health.)

**You must never use an APR in an IDLH situation.** If the APR stops working, for example if the filter or cartridge gets used up, then you will risk death or permanent damage to your health.

## How Long Do the Filters or Cartridges Last?

### IDLH

---

Never use an APR in IDLH conditions.

The only type of respirator allowed in IDLH conditions is an atmosphere supplying respirator.

---

## Assigned Protection Factors

The protection factor means how much cleaner the air is supposed to be in the respirator, compared to the contaminated air outside the respirator.

The **protection factor** means how much cleaner the air in the respirator is assumed to be if you pass a qualitative fit test. (In the qualitative fit test we don't actually measure the air – that's why we use an assigned protection factor to assume how much cleaner it is inside the mask.)

For example, a PF of 10 means the air in the respirator is supposed to be ten times cleaner than the outside air. If the contaminated air has 1000 ppm, then the air in the respirator – what you breathe – ought to be 100 ppm.

If you pass a qualitative fit test, you assume that the respirator has at least the protection indicated by the PF.

### OSHA Assigned Protection Factors (PF)

[29 CFR 1910.134(d)(3)(i)(A)]



Quarter-face  
APR: 5

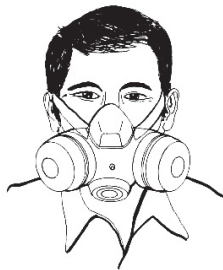

Half-face APR: 10



Full-face APR: 50



Full-face  
PAPR: 1,000



SCBA: 10,000



Air line with  
escape cylinder:  
1,000



Air line without  
escape cylinder:  
1,000

It is important that you understand when you can – and cannot – use an air purifying respirator.

APR's can only be used when:

- There is at least 19½% oxygen.
- There will be no confined space entry (unless it is established by air monitoring before and during entry that contaminant levels cannot rise above the range of the available APR filters or cartridges).
- You know the identity of the contaminants – so you can pick the right cartridge or filter.
- You know the concentration of the contaminants – so you can know if the respirator is rated for this concentration.
- There are no IDLH concentrations.
- There is a correct APR filter or cartridge available.

If there is a possibility that the situation might change for the worse – a leak might occur or a fire might start – then you won't know what the contaminants or concentrations are. Don't rely on an APR.

Look at the NIOSH Pocket Guide and at the manufacturer's selection chart to see what type of respirator you need to use.

## Choosing the Right Respirator

---

Unless you can say “yes” to all of these conditions, then it is unsafe to enter the area with an APR.

---

---

Under certain conditions it is unsafe to use an air purifying respirator. Then you have to use an atmosphere supplying respirators.

---

## Inspecting and Checking Your Respirator



Every time before you use a respirator you should inspect it. When you put it on you should perform a couple of quick seal checks.

User inspection.

- Make sure that you have the correct respirator and the correct filters or cartridges.
- Inspect the face piece, straps and visor.
- Inspect the inhalation and exhalation valves.

Negative pressure check.

- With your hands, cover the inlets to the filters or cartridges.
- Inhale. If the respirator is working properly, then you should be able to feel the face piece being sucked toward your face.
- Hold your breath for 10 seconds. The face piece should remain sucked in.

Positive pressure check.

- Cover the exhalation valve with your hand.
- Exhale. You should be able to feel the respirator expanding away from your face.
- Again, hold it for 10 seconds.

Your employer is required by the OSH Act to provide a safe and healthy workplace. If the only way to make the work site safe and healthy is to use personal protective equipment, such as respirators, face shields, hard hats, and chemical protective clothing, then the employer must pay for it.

In the past there was some uncertainty about which types of personal protective equipment the employer was required to pay for. A new OSHA standard, with which employers must comply beginning May 15, 2008, makes this requirement clear.

Your employer must pay for all necessary personal protective equipment except:

- Everyday clothing like long-sleeve shirts, pants, street shoes and normal work boots.
- Items used solely for protection from the weather, such as winter coats, gloves, parkas, rubber boots, hats, raincoats, sunscreen, and sun glasses.
- Non-specialty work shoes and boots - even if they have steel toes - if the employer permits you to wear these shoes and boots off the job.
- If the employer provides separate metatarsal guards, then the employer does not have to pay for special boots with the guards built in.
- If the worker is responsible for losing or damaging an item of personal protective equipment, then the employer can require the worker to pay for the replacement item.

**Your Employer  
Pays for Most  
Personal  
Protective  
Equipment**  
[29 CFR 1926.95(d)]

Module

6

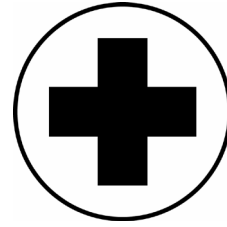

## Health Hazards and HAZCOM

### Learning objectives

This module reviews the health hazards caused by chemicals that you might use or be exposed to on a construction site.

This module also reviews the OSHA Hazard Communication Standard - known as HAZCOM - that requires you to receive training and information about the hazardous chemicals at your work site.

After completing this module you will be able to demonstrate your ability to:

1. IDENTIFY examples of adverse health effects from occupational exposure to chemicals.
2. IDENTIFY the proper definition of these terms:

A. Cancer	D. Latency Period	G. Systemic Effect
B. Acute Effect	E. Target Organ	
C. Chronic Effect	F. Local Effect	
3. IDENTIFY five routes of entry: five ways that chemicals get into or on your body.
4. IDENTIFY two examples of chronic effects of chemical exposure.
5. IDENTIFY two examples of acute effects of chemical exposure.



6. IDENTIFY the five major requirements of the OSHA HAZCOM Standard.
7. IDENTIFY the kinds of information about a chemical that you can find on its SDS.
8. LIST three types of information which must be on a chemical label.



## Chemicals and Your Health

There are many ways hazardous chemicals can affect you. You might get a rash, feel sick or become dizzy. Your liver, lungs or other organs might be damaged. Your ability to have children might be affected. You might get cancer. The effect depends on the chemical, how much you absorb, and your own state of health.

We divide hazardous chemicals into several categories:

- Asphyxiants (lack of oxygen).
- Corrosives.
- Irritants.
- Sensitizers.
- Toxins (poisons).

A single chemical might fit into more than one category. For example, an acid might be corrosive (burn your skin) and be a poison (if it gets inside you).

Lack of oxygen is called asphyxia. There are two ways that chemicals can cause a lack of oxygen:

- Displacing the oxygen in the air.
- Interfering with how the body uses oxygen.

**The normal amount of oxygen in the air is 21%.**

OSHA says that you may not work in an area with less than 19½% oxygen. [29 CFR 1910.146(b)]

---

**Corrosives** burn any tissue they contact: skin, eyes, mouth, nose, esophagus, stomach, and lungs. (Examples: acids like sulfuric acid or hydrofluoric acid; and bases like ammonia and lye.)

---

**Irritants** cause redness, swelling, itching or burning of the eyes and skin. If inhaled, they cause coughing, or difficulty breathing. (Examples: solvents, weak solutions of ammonia, weak solutions of acids.)

---

**Sensitizers** cause some people to become “sensitized”, and react to even a very small exposure. They suffer asthma-like symptoms, or skin irritation. (Examples: formaldehyde, nickel, and toluene-di-isocyanide.)

## Lack of Oxygen (Asphyxia)

---

Any gas or vapor can be a simple asphyxiant if enough is released to displace oxygen in the air.

## Corrosives

## Irritants

## Sensitizers

## Toxins (Poisons)

There are many kinds of toxins (poisons) – depending on what organs or parts of the body they damage.

Liver toxins (hepatotoxins) can cause hepatitis, cirrhosis, or liver failure. (Examples: ethyl alcohol, PCB's, carbon tetrachloride, vinyl chloride.)

Neurotoxins affect nerves. Some affect the brain (central nervous system) causing dizziness, nausea, headaches, poor coordination, or behavior changes. Other neurotoxins affect the nerves that go to other parts of the body (peripheral nervous system) causing numbness, tingling, weakness or tremors. (Examples: lead, mercury, organic solvents.)

Kidney toxins (nephrotoxins) damage the kidneys, and may cause kidney failure. (Examples: lead, cadmium, mercury, methyl alcohol, carbon tetrachloride.)

Respiratory toxins damage the lungs and airways. Ozone and phosgene gas cause fluid to collect in the lungs (edema). Asbestos and silica cause lung scarring. Asbestos and tobacco smoke can cause lung cancer.

Blood toxins (hematopoietic toxins) affect the blood, or the organs that make blood cells. (Example: benzene.)

Reproductive toxins affect your ability to conceive, or give birth to normal, healthy children. Possible effects include low sperm count, deformed sperm, impotence, menstrual irregularities, infertility, miscarriage, low birth weight and birth defects. (Example: ethyl alcohol.)

## Cancer

Cancer is the uncontrolled growth of abnormal cells. Cancer is what happens when some cells begin to “misbehave”, and enough of these “cancer” cells grow so that they cause a problem.

For example, the cells in your lungs form a structure which expands and contracts as you breathe. Some cells form the air passages, others let oxygen pass into your blood. If some cells grow into a mass that interferes with the passage of air or the normal expansion and contraction, then this mass of cells is called lung cancer.

Because there are different kinds of cells, there are different kinds of cancer: liver cancer, lung cancer, leukemia (blood cancer), skin cancer and so forth.

Chemicals that increase your risk of getting cancer are called **carcinogens**. Just because you are exposed to a carcinogen doesn't mean you'll get cancer.

Not all chemicals cause cancer. We need to identify the ones that do, and keep our exposure as low as possible. Very few chemicals have actually been studied to see if they are carcinogens.

---

Cancer is the uncontrolled growth of abnormal cells that interfere with the way your body is supposed to work.

---

---

Chemicals that increase your risk of cancer are called carcinogens.

---

---

To decrease your risk, keep your exposure as low as possible.

---

### Some Examples of Chemical Carcinogens

Chemical	Type of Cancer	Chemical Uses
Asbestos	Lung cancer, mesothelioma	Insulation, brake linings
Arsenic	Lung cancer	Pesticides, pigments, smelter residue
Benzene	Leukemia	Chemical manufacture, solvents
Benzidine	Bladder cancer	Manufacture of dyes, plastics, chemicals
Chromium	Lung cancer	Welding fume, plating fume and residue
Coat tar	Skin and scrotal cancer	Fly ash, roofing and sealing compounds
Naphthalene	Bladder cancer	Manufacture of dyes, rubber, chemicals
Vinyl chloride	Liver cancer	Manufacture of polyvinyl chloride (PVC)

## **Chemical Forms and Health Effects**

The form of a chemical has a lot to do with how it affects our health, and with how we protect ourselves.

Very small particulates, like welding fumes, penetrate deep into the lungs when we inhale – and stay there. A larger particulate, like sawdust, might be caught in the nose, and we can blow it out. Fibers, like asbestos, because of their long, thin shape, also penetrate deep into the lungs.

Small particulates are also harder to trap in a respirator filter than larger particulates. For fumes, fibers and very small dusts we need a much better filter than we would need for sawdust.

Vapors and gases, because they are individual molecules, can penetrate deep into the lungs – where they can be absorbed into the blood.

Vapors and gases are difficult to capture in a respirator cartridge. For many gases and vapors there is no cartridge that works – we have to use a respirator with its own air supply.

---

## **Air Contaminants**

Air contaminants are hazardous chemicals in the air.

In order to be small enough to stay in the air and be inhaled, the chemical must either be in the form of a gas or a particulate. All air contaminants are either:

- Gases and vapors
- Particulates

Gases and vapors are the same thing: individual molecules in the air. Particulates include dusts, fibers, fumes, mists and sprays.

## Gases and Vapors

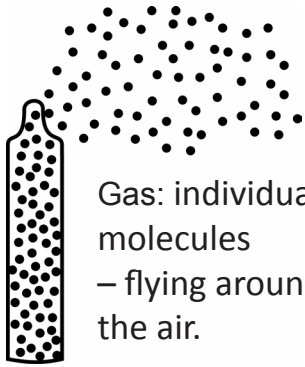

Gas: individual molecules – flying around in the air.

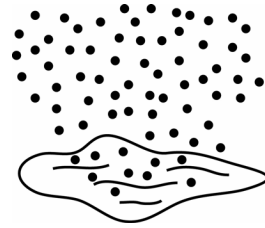

Vapor: a gas that evaporates from a liquid or solid.

## Particulates



Dust: Tiny solid particles – floating in the air.



Fibers: Tiny solid particles – much longer than wide – floating in the air.

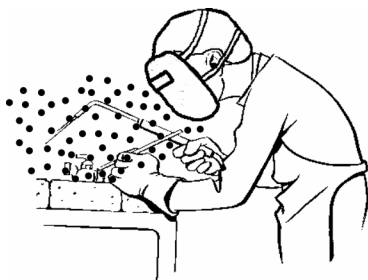

Fume: Very tiny solid particles – from hot processes – floating in the air.

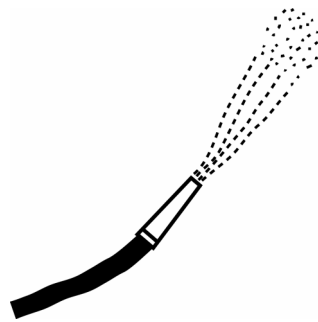

Mist and Spray: Tiny liquid pieces – floating in the air.

## Routes of Entry

In order for a hazardous material to affect your health, it has to get into or on your body. The different ways that chemicals do this are called **routes of entry**.

1. **Inhalation** is breathing in a hazardous material. It may damage the lungs, and it may be absorbed in the blood and carried to other parts of your body.
2. **Skin or eye contact** is when a hazardous material gets on your skin or in your eye.
3. **Skin absorption** is when a hazardous material gets on your skin and soaks through. It then enters the blood and is carried to other parts of your body.
4. **Ingestion** is when you accidentally swallow a material. This might happen if the material gets on your hands, and then on the sandwich you eat.
5. **Injection** is when a sharp object punctures the skin, allowing a chemical or infectious agent to enter.

Chemicals can use more than one route of entry. For example, if you handle a leaking container of solvent, you may get some on your hands. It can irritate your skin. It can also soak through, into your blood, and reach your liver or other organs. It can also evaporate and you will inhale it. The solvent affects you by skin contact, skin absorption, and inhalation.

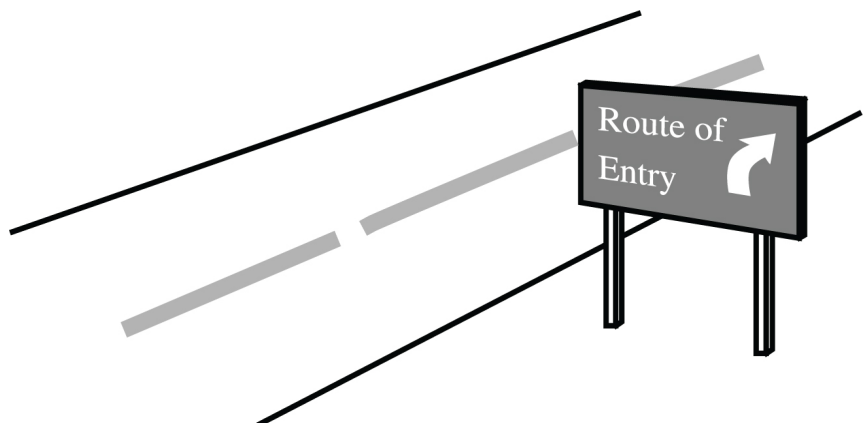



If a chemical causes damage where it comes in contact with your body, this is called a local effect. For example, if acid spills on your hand, the skin burn is a local effect. When you inhale ammonia, the irritation in your nose, throat and airways is a local effect.

If a chemical is absorbed — by whatever route of entry — and travels through your system to damage another organ, this is called a systemic effect. For example, suppose you inhale solvent vapors and start to feel dizzy. The solvent has been absorbed through the lungs, traveled in the bloodstream and caused an effect in your brain. Another example might be a chemical that soaks through your skin and then causes damage to your liver.

Many chemicals produce both local and systemic effects. For example, inhaling a solvent might irritate the nose and lungs. This is a local effect: it happens where the chemical comes in contact with your body. But the solvent will also be absorbed in the lungs and carried by the blood to the liver, kidneys and brain. Damage to these other organs is a systemic effect.

In any case, the organs that a chemical affects are called target organs.

## Local and Systemic Effects

---

Local effect: Occurs where the chemical contacts your body.

---

---

Systemic effect: Occurs in some other organ after the chemical has circulated through your system.

---



Local effect, systemic effect and target organ have to do with where the chemical affects you.

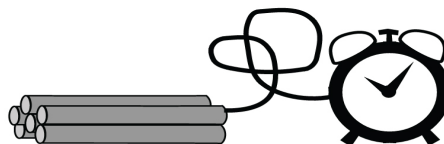

Acute effect, chronic effect and latency period have to do with when the chemical affects you.

## Short Term and Long Term Effects

---

Acute = short term  
Chronic = long term

---

---

Latency Periods: Average Years After Exposure for Cancer to Appear	
Asbestos .....	33 yrs
Chromates .....	21 yrs
Arsenic.....	25 yrs
Napthylamine .....	22 yrs
Benzene.....	10 yrs
Vinyl chloride.....	15 yrs
Benzidine.....	16 yrs

---

Some chemicals cause effects that occur right away. If acid gets in your eye, it causes a painful burn immediately. If you inhale ammonia vapor, you cough and feel irritation in your nose and airways right away. This is called a **short-term effect** or **acute effect**.

If you breathe small amounts of asbestos fibers you won't even notice them. There are no acute effects. But if you inhale asbestos month after month, year after year, you greatly increase your chances of getting lung cancer. This is a **long-term effect** or **chronic effect**.

It may take many years between the time you were exposed and when symptoms begin to appear. This is called the latency period. For some diseases, like cancer, the **latency period** can be twenty, thirty or more years.

The same chemical can cause both kinds of effects. For example, toluene is a chemical used in paints and solvents, and in the cement for plastic models. Inhale toluene and you can get dizzy or "high", and feel respiratory irritation. Toluene can also dry and irritate the skin. These are acute effects. However, if you are exposed again and again, toluene will damage your liver and destroy brain cells. These are chronic effects.

We usually notice acute effects. For example, acid burns and we feel it almost immediately. Just one whiff of ammonia vapor can make you cough. These effects can warn us to take precautions.

Unfortunately, you usually won't notice chronic effects until it's too late, because they happen slowly and it takes a long time to develop symptoms. You have to learn the possible chronic effects of the chemicals you work with. Then you will know that you must be careful, and what precautions to take, even if the materials don't cause any immediate effects.

The OSHA Hazard Communication Standard, or HAZCOM requires employers to have: [29 CFR 1910.1200 and 1926.59]

1. **Written HAZCOM program** to inform workers of chemical hazards.
2. **Material Safety Data Sheet (MSDS)/Safety Data Sheets (SDS)** for each hazardous chemical in the workplace, and make these MSDS/SDSs available to workers.
3. **Labels** on all containers of hazardous chemicals.
4. **List of hazardous chemicals** in the workplace, and make this list available to workers.
5. **Training** workers about:
  - The Hazard Communication Standard.
  - The employer’s HAZCOM program.
  - The operations or locations in the workplace where hazardous chemicals are present.
  - What hazardous chemicals are present.
  - How to use MSDS/SDSs.
  - How to interpret chemical labels.
  - How to detect the presence of chemicals.
  - The health and safety hazards of the chemicals.
  - Safe work practices, protective equipment and emergency procedures for the chemicals.

HAZCOM requires your employer to tell you the “what, where and how” of the hazardous chemicals in your work place.

## The OSHA HAZCOM Standard

---

OSHA recently changed the rules- until 2015, both Material Safety Data Sheets (MSDSs) and Safety Data Sheets (SDSs) are acceptable. After 2015, only Safety Data Sheets are.

---

---

Before December 1, 2013, **ALL WORKERS** must receive training from their employers on the changes to the HAZCOM Standard.

---

## Chemical Labels

---

Under the new HAZCOM Standard, all chemical labels must include a pictogram describing the hazards presented by the product. See page 90 for a list of the pictograms.

---

---

There is an exception: If the secondary container is only used by one worker for only one shift, then it doesn't have to be labeled.

---

Labels on chemical containers must include:

1. The **name of the product**.
2. **Name, address and phone number** of the manufacturer or importer.
3. The **hazards of the product**, including:
  - A precautionary word, such as DANGER, CAUTION or WARNING.
  - The physical hazards of the product.
  - The health hazards of the product.
  - The target organs which the product may affect.
  - Precautions and protective equipment.
  - Emergency first aid information.
4. **Pictogram**: Under the **new HAZCOM Standard**, all labels will be required to display a pictogram describing the nature of the hazard presented by the product. See page 90 for the approved pictograms.

The label may include a CAS number, which is a unique "social security" number for each chemical. This is helpful because most chemicals have more than one name. If you look in another information source you can be sure that you are getting information about the right chemical if you verify the CAS number.

The label might also include a UN/NA identification number, which is the DOT number for the chemical, or for the group of chemicals it belongs to.

If you transfer a chemical to a secondary container, HAZCOM requires the secondary container to be labeled also. For example, if you fill a one-quart can and take it to the repair shop, this secondary container also needs a label.

As of June 1, 2015, your employer is required to have a **Safety Data Sheet (SDS)** for every hazardous chemical used in the workplace.

SDS's must be available to all workers on all shifts.

Sixteen types of information must be on the SDS:

1. Identification Information
2. Hazard Identification
3. Composition/Information on Ingredients
4. First-Aid Measures
5. Fire-Fighting Measures
6. Accidental Release Measures
7. Handling and Storage
8. Exposure Controls/Personal Protection
9. Physical and Chemical Properties
10. Stability and Reactivity
11. Toxicological Information
12. Ecological Information
13. Disposal Considerations
14. Transport Information
15. Regulatory Information
16. Other Information (date of preparation or last revision)

**See the next page for all of the new pictograms.**

## **Safety Data Sheet (SDS)**

---

### **Section 2: Hazard**

**Identification** is where you will find the pictogram(s) describing the hazards presented by this product.

---

# HAZCOM Pictograms

Health Hazard



- Carcinogen
- Respiratory Sensitizer
- Reproductive Toxicity
- Target Organ Toxicity
- Mutagenicity
- Aspiration Toxicity

Flame



- Flammables
- Self-Reactives
- Pyrophorics
- Self-Heating
- Emits Flammable Gas
- Organic Peroxides

Exclamation Mark



- Irritant
- Dermal Sensitizer
- Acute Toxicity (harmful)
- Narcotic Effects
- Respiratory Tract Irritation
- Hazardous to Ozone Layer (Non-Mandatory)

Gas Cylinder



- Gases Under Pressure

Corrosion



- Skin Corrosion/Burns
- Eye Damage
- Corrosive to Metals

Exploding Bomb



- Explosives
- Self-Reactives
- Organic Peroxides

Flame Over Circle



- Oxidizers

Environment  
(Non-Mandatory)



- Aquatic Toxicity

Skull and Crossbones



- Acute Toxicity (Fatal or Toxic)

Until June 1, 2015, your employer is allowed to use a **Material Safety Data Sheet (MSDS)** instead of the Safety Data Sheet (SDS).

Twelve types of information must be on the MSDS:

1. Identity of the chemical.
2. Physical and chemical characteristics.
3. Physical hazards (fire, explosion, reactivity).
4. Health hazards (signs and symptoms of exposure, medical conditions aggravated by exposure).
5. Routes of entry.
6. Exposure limits (OSHA PEL, ACGIH TLV, etc.).
7. Whether the chemical is a carcinogen.
8. Precautions for safe handling.
9. Control measures (engineering controls, work practices and personal protective equipment).
10. Emergency and first aid procedures.
11. Date the MSDS was prepared.
12. Name, address and phone number of the manufacturer or importer.

---

The new HAZCOM Standard doesn't take effect immediately- until June 1, 2015, both the MSDS and the SDS are acceptable. **After June 1, 2015, your employer MUST use provide you with a Safety Data Sheet.**

These are the important dates for the new HAZCOM Standard:

- December 1, 2013- Your employer is required to provide you training on the new HAZCOM Standard.
- June 1, 2015- Your employer is required to replace all MSDSs with SDSs.
- June 1, 2016- Your employer is required to update all chemical labels, as well as update their Hazard Communication Program.

## **Material Safety Data Sheet (MSDS)**

## **HAZCOM Implementation Schedule**

# NFPA Hazard Identification System

The NFPA Hazard Identification System is intended to provide information to fire fighters during an emergency

The higher the number, the greater the hazard. "4" is the most extreme hazard.

The NFPA Hazard Identification System provides information to fire fighters in an emergency. You will find the diamond shaped NFPA labels on containers, storage tanks, doors and walls.

"0" means no hazard. "4" means the most severe hazard. The bottom diamond is for special information, such as "radioactive", or "water reactive".

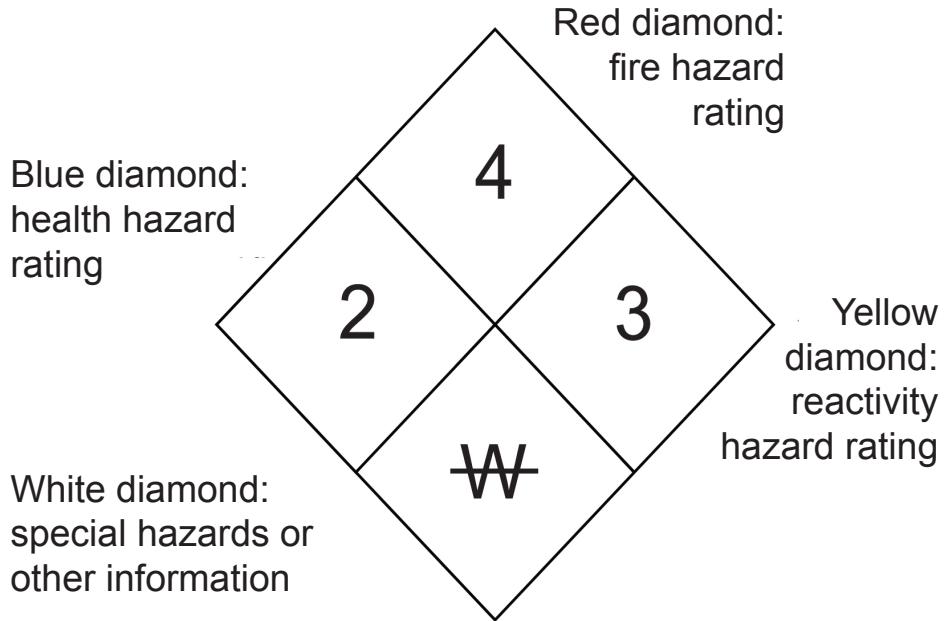

The NFPA label does not identify the chemical. It does not give specific health effects. It also does not identify the manufacturer. These are all things which OSHA requires on product labels.



The US Department of Transportation (DOT) has requirements for placards, labels and other markings on hazardous materials in transportation. These can help you identify the chemical hazards in your work place.

## DOT Placards, Labels and Markings

DOT divides hazardous materials into nine classes indicated by the numbers on the placards below. See the next page for a list of these DOT hazard classes.

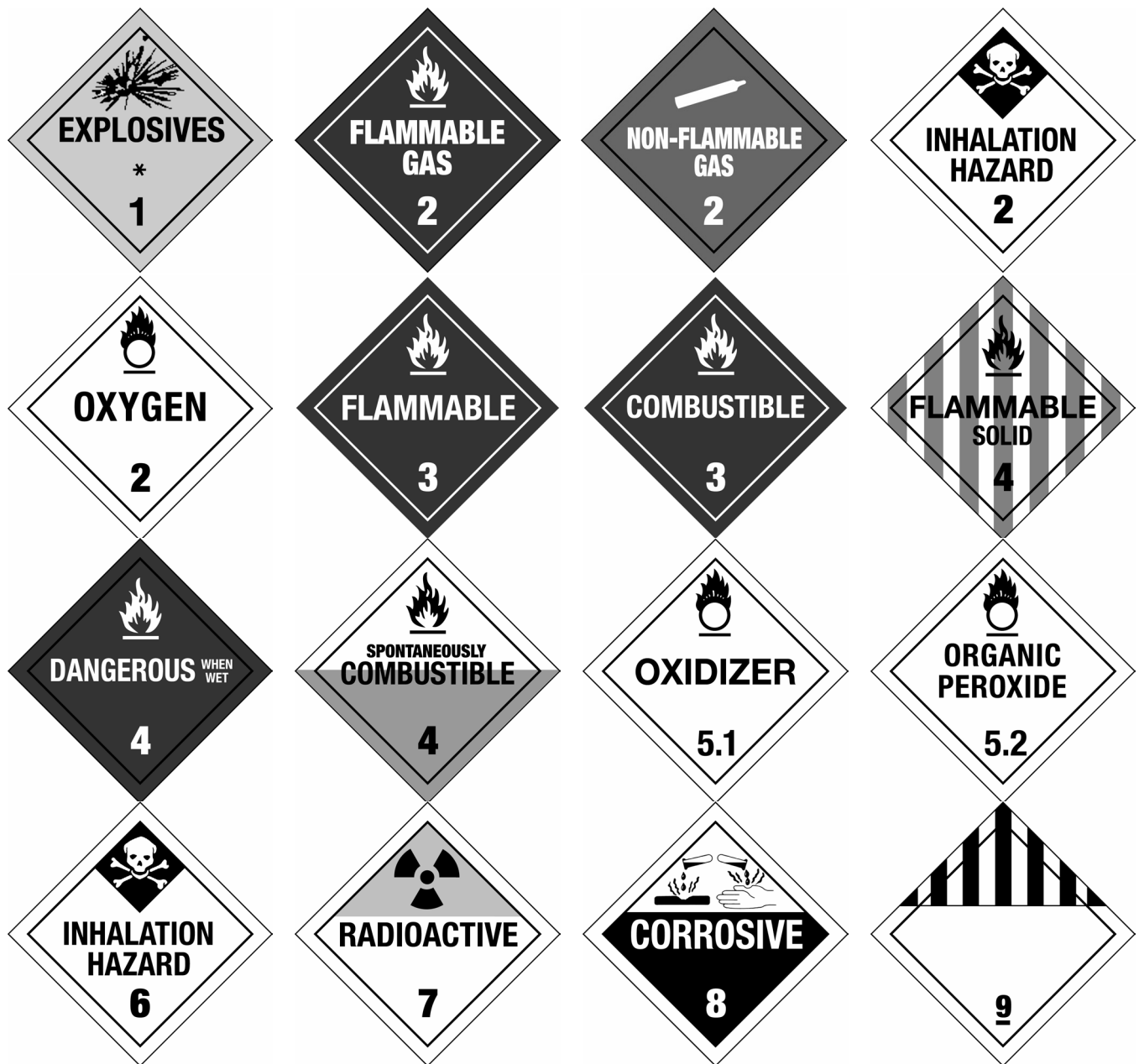

## DOT Hazard Classes and Divisions

<b>Class 1</b>	Division 1.1	Explosives (with a mass explosion hazard)
	Division 1.2	Explosives (with a projection hazard)
	Division 1.3	Explosives (with predominately a fire hazard)
	Division 1.4	Explosives (with no significant blast hazard)
	Division 1.5	Very insensitive explosives, blasting agents
	Division 1.6	Extremely insensitive detonating substances
<b>Class 2</b>	Division 2.1	Flammable gas
	Division 2.2	Nonflammable compressed gas and oxygen
	Division 2.3	Poisonous gas
<b>Class 3</b>	<b>Flammable and combustible liquids</b>	
<b>Class 4</b>	Division 4.1	Flammable solid
	Division 4.2	Spontaneously combustible material
	Division 4.3	Dangerous when wet
<b>Class 5</b>	Division 5.1	Oxidizer
	Division 5.2	Organic peroxide
<b>Class 6</b>	Division 6.1	Poisonous materials
	Division 6.2	Infectious substances (etiologic agent)
<b>Class 7</b>	<b>Radioactive material</b>	
<b>Class 8</b>	<b>Corrosive material</b>	
<b>Class 9</b>	<b>Miscellaneous hazardous material</b>	
<b>ORM-D</b>	<b>Other regulated material</b>	

- notes -

Module

7



## Stairways and Ladders

### Learning objectives

This module reviews the OSHA Standard for the safe use of stairways and ladders at construction sites.

After completing this module you will be able to demonstrate your ability to:

1. IDENTIFY the general requirements for safe use of stairs.
2. IDENTIFY the general requirements for safe use of ladders.
3. IDENTIFY when fall protection is required for a fixed ladder.
4. IDENTIFY when a ladder with non-conductive side rails is required.
5. IDENTIFY the proper procedures for dealing with defective ladders.

**Stairways and Ladders** is Subpart X of the OSHA Construction Standard. It has five sections and one non-mandatory appendix, as shown in the box below.

## Overview of the OSHA Standard

Stairways and ladders are a major source of injuries and fatalities among construction workers. OSHA estimates that there are 24,882 injuries and as many as 36 fatalities per year due to falls from stairways and ladders used in construction. Nearly half of these injuries are serious enough to require time off the job.

Working on and around ladders and stairways is hazardous.

### Stairways and Ladders 29 CFR 1926, Subpart X

Scope, Application and Definitions .....	29 CFR 1926.1050
General Requirements .....	29 CFR 1926.1051
Stairways .....	29 CFR 1926.1052
Ladders .....	29 CFR 1926.1053
Training Requirements .....	29 CFR 1926.1060
Non-Mandatory Appendix A, Ladders	

## Scope and Application

[29 CFR 1926.1050]

This standard applies to all stairways and ladders used in construction. This includes ladders and stairways made on the job. However, ladders and stairways that are specifically manufactured for scaffolds are covered by Subpart L, Scaffolds (29 CFR 1926.451).

---

## General Requirements

[29 CFR 1926.1051]

There must be a ladder any place where workers are expected to go up or down more than 19 inches, unless there is a ramp, slope or hoist. At least one point of access between levels must be kept clear at all times.

Before any worker uses a stairway or ladder, the employer must make sure that the stairway or ladder complies with this Subpart. This includes fall protection systems which are required for some ladders and stairways.

---

## Stairways

[29 CFR 1926.1052]

**Landings:** Stairways that will not be a permanent part of the structure must have landings at every 12 feet of vertical rise. Each landing must be at least 30 inches deep and 22 inches wide.

**Angle:** Stairways must be installed at least 30 degrees — and no more than 50 degrees — from the horizontal.

**Treads and Risers:** The risers should all be the same height, and the treads should all be the same depth. No more than  $\frac{1}{4}$  inch of variation is allowed.

## Stairways

[29 CFR 1926.1052]

(Continued)

**Doors and Gates:** If a door or gate opens directly onto a stairway, there must be a platform that extends at least 20 inches beyond the swing of the door.

**Metal Pan Stairways:** Landings and treads of metal pan stairways must be secured in place before they are filled. Before workers can use a metal pan stairway, it must be permanently filled with concrete, or temporarily filled with wood. Exception: Workers involved in the actual assembly or construction of the stairway may use it while they are working on it, even if it hasn't been filled.

**Slippery Conditions:** Keep stairways free of ice, snow, oil or other slippery conditions.

**Handrails and Stair Rails:** Note: "Handrail" means rail used to provide a hand hold for support. "Stair rail" means a barrier to keep you from falling off. A stair rail can serve as a handrail, or they may be two separate parts of the same stairs.

Stairways with four or more risers, or rising more than 30 inches in height — whichever is less — must have at least one handrail. The handrail must be between 30 and 37 inches above the steps. Handrails must be strong enough to take a force of at least 200 pounds. Temporary handrails must have a minimum clearance of 3 inches between the handrail and wall.

Each unprotected side or edge of a stairway must also have a stair rail. A stair rail must be at least 36 inches high. If it also serves as the handrail, then it must not be more than 37 inches high. A stair rail must have screen, mesh, or balusters between the top rail and the steps.

## Ladders

[29 CFR 1926.1053]

**Ladder Traffic.** If the only way to enter or leave the work area is by ladder, and there are 25 or more workers in the area, then there must be at least two ladders, or a double-cleated ladder.

Two ladders, or a double-cleated ladder are also required if there is up and down use at the same time.

**Rungs, Cleats and Steps.** Rungs, cleats, and steps must be parallel, level, and uniformly spaced when the ladder is in position for use.

Rungs, cleats, and steps of portable and fixed ladders must be spaced between 10 inches and 14 inches apart.

**Connecting Ladders Together.** Never tie or fasten ladders together to create a longer ladder unless they are specifically designed for this purpose.

When splicing side rails, the resulting side rail must be equivalent in strength to a one-piece side rail made of the same material.

Two or more separate ladders used to reach an elevated work area must be offset with a landing between the ladders, except when portable ladders are used to gain access to fixed ladders.

**Wood Ladders.** Wood ladders must not be painted with an opaque covering, except for identification or warning labels which may be placed only on one face of a side rail. This is so cracks or other defects can be seen.

**Portable Ladders.** Portable ladders must be strong enough to support at least four times the maximum intended load.

The side rails of portable ladders must be at least 11½ inches apart.



The rungs and steps of portable metal ladders must be corrugated, knurled, or coated with skid-resistant material to minimize slipping.

**Fixed Ladders.** A fixed ladder must be able to support at least two loads of 250 pounds each, concentrated between any two consecutive attachments. Fixed ladders also must support added loads caused by ice buildup, winds, rigging, and impact loads resulting from using ladder safety devices.

Each step or rung of a fixed ladder must be able to support a load of at least 250 pounds applied in the middle of the step or rung.

Fixed ladders must reach at least 42 inches above an access level or landing platform. This can be done in either of two ways. There can be horizontal grab bars, or vertical grab bars with the same spacing as the ladder's side-rails.

Fixed ladder side rails must be at least 16 inches apart.

If a fixed ladder is made up of separate rungs attached to the structure without side rails, then the rungs must be shaped to prevent slipping off the ends.

There must be at least 7 inches of clearance between the rungs of a fixed ladder and the structure to which it is attached. There must be at least 30 inches of clearance on the climbing side of a fixed ladder. An exception is if obstructions are unavoidable, the clearance may be reduced to 24 inches if a deflection device is installed.

The step-across distance between rungs of fixed ladders and the nearest edge of a landing must be at least 7 inches and no more than 12 inches.

## **Fall Protection on Ladders**

[29 CFR 1926.1053]

If the total length of climb is 24 feet or more, then a fixed ladder must have some kind of fall protection. This can be any of the following:

- Ladder safety devices.
- Self-retracting lifelines and rest platforms at least every 150 feet.
- A cage or well. If the total length of climb is more than 50 feet, the ladder must be in multiple sections, with each section not to exceed 50 feet. Each section must be offset from adjacent sections with a landing platforms.

If the length of climb is less than 24 feet, but the top of the ladder is more than 24 feet above a lower level, then there must also be a cage, well, ladder safety device, or self-retracting lifeline.

## **Ladder Safety Devices for Fixed Ladders**

[29 CFR 1926.1053]

---

All safety devices must be able to withstand a drop test consisting of a 500 pound weight dropping 18 inches.

All safety devices must permit the worker to ascend or descend without continually having to hold, push, or pull any part of the device, leaving both hands free for climbing.

All safety devices must be activated within 2 feet after a fall occurs.

The connection between the carrier or lifeline and the point of attachment to the body harness must not be longer than 9 inches.

A **competent person** must inspect all ladders for visible defects on a regular basis and after any incident that could affect their safe use. Keep ladders free of slipping hazards like oil and grease.

If a you use a ladder near energized electrical equipment, it must have wood or fiberglass side rails.

A ladder leaning against a structure must be at an angle so that the horizontal distance from the top support to the foot of the ladder is approximately one-quarter of the working length of the ladder.

Make sure that the ladder is on a stable and level surface, or is secured to prevent accidental movement.

Face the ladder when ascending or descending.

Don't load a ladder beyond the manufacturer's rated capacity. Don't carry anything on a ladder that might cause you to lose your balance.

Never use the top or top step of a stepladder as a step.

If you use a portable ladder for access to an upper landing, the side rails must extend at least 3 feet above the landing surface. If this is not possible, then the ladder must be secured, and a grab rail must be provided to assist workers in getting on and off the ladder at the landing.

If you use a ladder where it might be displaced by activities or traffic, then it must be secured to prevent accidental movement or protected by a barricade.

Keep the area at the top and bottom of the ladder clear.

Never move a ladder while some one is on it.

## Using Ladders

[29 CFR 1926.1053]

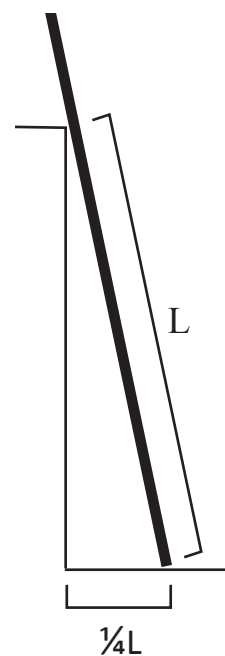
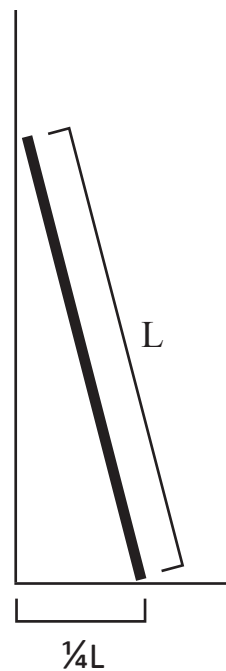

## **Ladder Defects**

[29 CFR 1926.1053]

If a ladder has any structural defect (such as broken or missing rungs, split rails, corroded components, or other defects) immediately tag or mark it “Do Not Use” and withdraw it from use. To withdraw a fixed ladder from use either: (1) tag it or mark it “Defective”, or (2) block the rungs with plywood so it cannot be used.

Ladder repairs must restore the ladder to a condition meeting its original design criteria before the ladder is returned to use.

---

## **Training Requirements**

[29 CFR 1926.1060]

Your employer must provide a training program for each employee using ladders and stairways. For example, employers must ensure that each employee is trained by a competent person in the following areas, as applicable:

- The nature of fall hazards in the work area.
- The proper use of any fall protection systems used with ladders.
- The proper construction, use, placement, and care of stairs and ladders.
- The maximum intended load-carrying capacities of ladders used.

In addition, employers must retrain each employee as necessary to maintain their understanding and knowledge.

- notes -

Module

8

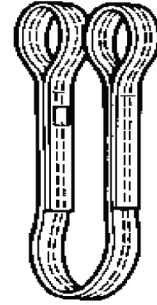

## Materials Handling, Storage, and Disposal

### Learning objectives

This module reviews the proper methods to move materials at a construction site, including the safe use of slings. This module also review the training requirements and safe work practices for operators of forklifts.

If you operate a powered industrial truck, you must have special training that includes hands-on practice with each type of truck that you will operate. This module provides a brief overview of forklift safety practices, but is not a substitute for the equipment-specific forklift training required by OSHA.

After completing this module you will be able to demonstrate your ability to:

1. IDENTIFY four safe work practices for storing materials.
2. IDENTIFY five safe work practices for operating powered industrial trucks (forklifts).
3. DESCRIBE how to determine the rated capacity of a sling.
4. IDENTIFY six things to consider before rigging a load with slings.
5. IDENTIFY five safe work practices when lifting a load with slings.

**Materials Handling, Storage, Use, and Disposal** is Subpart H of the OSHA Construction Standard. It has three sections as shown in the box below.

Handling and storing materials involves many different operations. For example: hoisting tons of steel with a crane, driving a truck loaded with concrete blocks, carrying bags of cement by hand, and stacking drums, lumber, or loose bricks.

The improper handling and storing of materials can cause serious injuries. Often the weight and bulkiness of an object is a major factor in injuries. Back injury is the most common and most costly workplace injury. Almost one-half million workers injure their backs every year. Moving materials by hand can also cause sprains and strains to other muscles and joints.

Fractures, lacerations and bruises result from being struck by moving or falling objects, by getting pinched between objects, or by incorrectly cutting strapping.

## Overview of the OSHA Standard

### **Materials Handling, Storage, Use, and Disposal 29 CFR 1926, Subpart H**

General Requirements for Storage	29 CFR 1926.250
Rigging Equipment for Material Handling	29 CFR 1926.251
Disposal of Waste Material	29 CFR 1926.252

### **Powered Industrial Trucks 29 CFR 1910.178**

This is an OSHA general industry standard that also applies to the construction industry. 29 CFR 1926.602(d)

## General Requirements

[29 CFR 1926.250]

**Don't Try to Do More Than You Can.** If a load is so bulky that you cannot properly grasp or lift it, or if it's so big that you cannot see past it, get help.

**Placing Blocks.** If you place blocks under a load, make sure that your hands are completely removed before the load is lowered onto the blocks.

**Gloves and Boots.** Wear work gloves and steel-toed boots when handling heavy materials.

**Moving Equipment.** When using forklifts or other equipment to move materials:

- Know the rated capacity of the equipment.
- Don't overload the equipment.
- Center the load.
- Keep the load in the lowest possible position while traveling.



## **Storage Areas**

[29 CFR 1926.250]

Keep storage areas free from accumulated materials that may cause tripping, fires, or that may contribute to the harboring of rats and other pests.

When stacking materials, be aware of such factors as the materials' height and weight, how accessible the stored materials are to the user, and the condition of the containers.

Know the load limits of the floor or rack. Don't overload it. Load limits should be posted in all storage areas.

Don't stack materials too high; they could fall. Know the proper maximum height for different materials and containers.

Stack bags in interlocking rows to remain secure. Step the layers back and cross-key the bags at least every ten layers. To remove bags from the stack, start from the top row first.

Sprinkler Heads. If there are fire sprinkler heads, don't stack materials so high that the heads are blocked.

Drums and Barrels. If drums and barrels are stacked on their ends, place planks or plywood between the tiers for added security. If stacked on their sides, make sure that the bottom tier is securely blocked to prevent rolling.

## Powered Industrial Trucks

[29 CFR 1910.178]

[29 CFR 1926.602(d)]

---

This module provides an overview of forklift safety practices, but is not a substitute for the equipment-specific forklift training required by OSHA.

---

**Capacity.** Each forklift or other industrial truck must be marked with its rated capacity. Don't overload it.

**Modifications.** Don't make any modifications without the manufacturer's prior written approval.

**Attachments.** Only use attachments that are designed to work with the particular truck.

**Fire and Explosion.** Internal combustion engines are very hot. Electric motors create sparks. In either case, the engine or motor could start a fire or explosion if there are flammable vapors, gases or particulates in the air. There are specially designed industrial trucks for use in dangerous atmospheres. These have enclosed electrical systems, guarded exhausts, and temperature limitation features.

**Toxic Exhaust.** Gasoline and diesel engines emit toxic substances in the exhaust, including carbon monoxide (CO). CO is an odorless, tasteless gas that is extremely deadly. A very small amount can make you feel dizzy and tired, and can affect your coordination. A little bit more can put you to sleep or kill you. Do not use gasoline or diesel powered industrial trucks indoors unless there is good ventilation. It's always better to use propane or electric powered trucks indoors.

**Charging Batteries.** Batteries can emit explosive hydrogen gas when they are charged. Battery electrolyte is extremely corrosive and can burn your skin or blind you. In the module on electrical hazards we discuss safe battery charging.

If you operate a powered industrial truck, you must have special training that includes hands-on practice with each type of truck that you will operate.

## Cranes and Derricks

We discuss the safe use of cranes in another module. Here we will only review a few basic principles:

- Only a qualified person can operate a crane or derrick.
- Know the load rating. Never try to lift more than the rated capacity.
- No workers should ever be under the load.
- Inspect the crane before each work shift.
- Follow maintenance and major inspection schedules.

---

Check all of these things before rigging the load:

- **Inspection.** Inspect the sling prior to use.
- **Modifications.** Never shorten a sling with knots, bolts or other makeshift devices.
- **Weight.** Determine the weight of the load and how it will be distributed if there is more than one sling.
- **Center of Gravity.** Determine the center of gravity of the load. Make sure that the load can be rigged with the hook directly above the center of gravity. Otherwise the load will tilt when it is raised.
- **Sling Angle.** The more vertical the legs of the sling are, the less strain there is on them. The closer they are to horizontal, the more strain they experience. Strain is the same as more weight. As the sling angle gets closer to horizontal, the sling can support less weight.
- **Number of Legs.** Determine the number of legs the sling or slings will have when the load is rigged.
- **Hitches.** Determine the type of hitch to use to secure the sling to the load and the sling to the hook.
- **Rated Capacity.** The manufacturer should supply a chart with the rated capacity of the sling at different angles and with different types of hitches. Use an extra margin of safety with older slings.

## Rigging the Load

## Safe Lifting with Slings

Follow these safe practices when lifting the load:

- Make sure that you have selected the proper sling for the job.
  - Make sure that you have rigged the load correctly.
  - Slowly take up the load a few inches at a time. Check the balance and load tension.
  - Keep other workers clear. Never let anyone go under the load.
  - Have only one person in charge and giving signals.
  - Don't raise the load higher, or leave it up longer than necessary.
  - After the maneuver, check the slings for damage.
- 

## Sling Materials

**Sling Materials.** Slings can be made of different materials. These include chain, wire rope, wire mesh, natural fiber rope, synthetic fiber rope, and synthetic webbing.

## Wire Rope

Wire rope is composed of individual wires that have been twisted to form strands. The strands are then twisted to form a rope.

Some wire rope has a fiber core. This makes it more flexible, but also more easily damaged. Wire rope with a wire core is stronger and more resistant to heat damage, but it is less flexible.

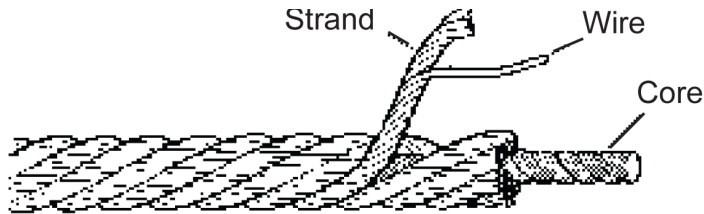

Lay is a term used to describe both fiber rope and wire rope. The word lay can have more than one meaning:

- One complete wrap of strands around the core.

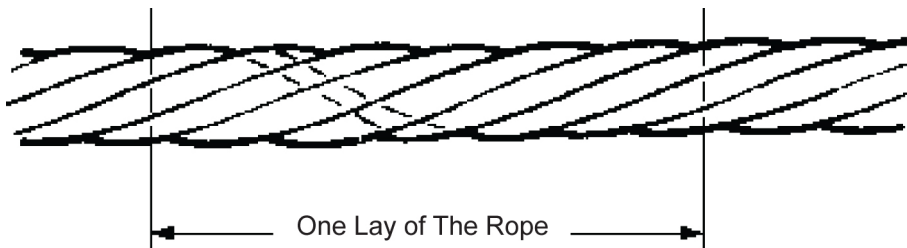

- The direction the strands are wound around the core. Wire rope is referred to as right lay or left lay. A right lay rope is one in which the strands are wound in a right-hand direction like a screw thread. A left lay rope is just the opposite.



Right Lay Rope

## Rope Lay

## Selecting the Proper Wire Rope Sling

---

For example: a new wire rope sling with a strength of 10,000 pounds would have a rated working load of 2,000 pounds.

If the strength decreases to 8,000 pounds over time, but the rated load is still considered to be 2,000 pounds, then there is only a 4 to 1 safety factor.

---

There are four characteristics to consider with wire rope: strength, ability to bend without distortion, ability to withstand abrasion, and ability to withstand abuse.

**Strength.** The maximum load limit is determined by dividing the ultimate strength of the rope by a safety factor. New wire rope has a safety factor of 5 to 1.

As the sling gets used, its ultimate strength declines because of wear and stretching. This makes it important to rigorously inspect wire rope slings, especially old ones, to ensure that they are still safe to use.

**Fatigue.** A wire rope has to withstand repeated bending without the wires breaking from fatigue. Fatigue failure results from small cracks that develop after repeated bending. Sharp bends cause more fatigue. Use rounded blocks or pads to increase the radius where the sling bends around a load.

**Abrasion.** The ability of a wire rope to withstand abrasion depends on the size, number of wires, and construction of the rope. Smaller wires are more flexible but are less able to withstand abrasion. Larger wires make the rope less flexible, but they are better able to withstand abrasion.

**Abuse.** Abusing a wire rope sling can cause serious structural damage to the wire rope, such as kinking or bird caging. This reduces the rope's strength. Bird caging is when the wire rope strands are forcibly untwisted and spread outward.

Wire rope slings must be visually inspected before each use. The operator should check the twists or lay of the sling. If ten randomly distributed wires in one lay are broken, or five wires in one strand of a rope lay are damaged, the sling must not be used.

Also inspect the end fittings and other components for any damage that could make the sling unsafe.

All workers who use slings should know how to recognize damage to slings, not just the foreman or the crane operator.

---

Lubrication makes a wire rope sling last longer. The wire rope stretches as it takes up a load. This means that all the wires in the rope move a little bit. Lubrication allows them to slip along each other without excessive wear.

The manufacturer provides the initial lubrication. The wire rope should also be lubricated from time to time as it is used. There is no set rule on how much or how often this should be done. It depends on the conditions under which the sling is used. The heavier the loads, the greater the number of bends, or the more adverse the conditions under which the sling operates, the more frequently lubrication will be required.

---

Wire rope slings should be stored in a ventilated, dry building. Never store them on the ground or allow them to be continuously exposed to the elements because this can cause corrosion and rust. If it is necessary to store a wire rope sling outside, make sure that it is set off the ground and protected.

Using the sling several times a week, even on a light load, is a good practice. Records show that slings that are used frequently or continuously give useful service longer than those that are idle.

## **Inspecting Wire Rope Slings**

## **Lubricating Wire Rope Slings**

## **Storing Wire Rope Slings**

## Discarding Wire Rope Slings

Discard a wire sling under the following conditions:

- Severe corrosion.
- Localized wear (shiny worn spots) on the outside.
- A one-third reduction in outer wire diameter.
- Damage to end fittings.
- Distortion, kinking, bird caging, or other damage to the rope structure.
- Excessive broken wires. If ten randomly distributed wires in one lay are broken, or five wires in one strand of a rope lay are damaged, the sling must not be used.

## Fiber Rope Slings

Fiber rope slings are pliant, they grip the load well and they don't mar the surface of the load. However, they are less strong than wire rope slings or synthetic web slings. Use fiber rope slings only for light loads. Don't use them to lift objects with sharp edges unless you can carefully pad the edges to protect the rope. Also, don't use fiber rope slings if they will be exposed to high temperatures, to corrosive materials or to abrasion.



Fiber rope deteriorates much more quickly than other sling materials. You should carefully inspect the sling before each load. First look at the outside for dry, brittle, scorched, or discolored fibers. Scratch the fibers with your finger nail. If they come apart easily, the fiber sling has suffered some kind of chemical damage.

Then carefully untwist a portion of the rope to look at the interior. It should be as clean as when the rope was new. A buildup of dust on the inside of the fiber rope indicates excessive internal wear.

If any of these conditions are found, the sling is unsafe. It must be discarded.



Synthetic slings are made of nylon, dacron or kevlar.  
Synthetic web slings have these properties:

- **Strength.** Some larger slings can handle loads of up to 300,000 pounds.
- **Flexible.** They can conform easily to the shape of the load.
- **Safety.** Because they fit the shape of the load, they are less likely to slip.
- **Load protection.** They are less likely to scratch the surface of the load.
- **Long life.** They don't rot or mildew. They have good abrasion resistance.
- **Shock absorbance.** Synthetics, especially nylon stretch to absorb shocks.

---

Discard synthetic web slings if any of the following defects exist:

- Chemical burns, including burns from acids and caustics.
- Melting or charring from excessive heat or friction.
- Snags, punctures, tears, or cuts.
- Broken or worn stitches.
- Damage from excessive exposure to sunlight.
- Distortion of fittings.
- Elongation. (Check the manufacturer's specifications.)

## Synthetic Web Slings

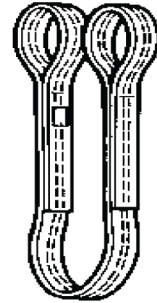

## Discarding Synthetic Web Slings

## Chains

**Chains.** Chains are used because of their great strength and their ability to adapt to the shape of the load. However, chain slings are subject to damage by sudden shocks. Misuse of chain slings can damage the sling, resulting in sling failure and possible injury to a worker.

Chain slings are also the best choice for lifting materials that are very hot. They can be heated to temperatures of up to several hundred degrees.

All sling types must be visually inspected prior to use. When you inspect an alloy steel chain sling, pay special attention to any stretching, excess wear, nicks and gouges. These are all indications that the sling may be unsafe and must be removed from service.

- notes -

Module

9

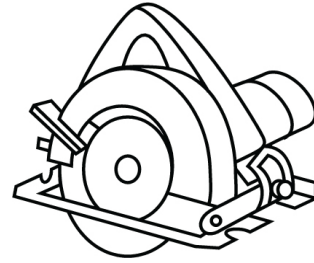

## Tools - Hand and Power

### Learning objectives

This module reviews tool hazards and the appropriate safe work practices and protective equipment required by OSHA when using tools.

After completing this module you will be able to demonstrate your ability to:

1. IDENTIFY seven basic safe work practices for tools.
2. IDENTIFY the importance and proper use of guards.
3. IDENTIFY three types of switches used on power tools.
4. IDENTIFY the hazards of electric tools.
5. IDENTIFY the hazards of abrasive tools
6. IDENTIFY the hazards of pneumatic tools.
7. IDENTIFY the hazards of powder-actuated tools.

Tools cause many kinds of injuries, including eye injuries, lacerations, punctures, amputations, electrocutions, and burns. Using a tool the wrong way can also cause muscle and joint problems that we call “ergonomic injuries.”

When we use tools we might make a hazardous situation even more risky. For example, if a tool jams or kicks back, a worker on a scaffold might lose his or her balance and fall. A worker using an electric tool near flammable liquids might ignite the vapors in the air and cause a fire or explosion.

Tools – Hand and Power is Subpart I of the OSHA Construction Standard. It has eight sections, as shown below:

<b>General Requirements</b> 29 CFR 1926.300	<b>Hand Tools</b> 29 CFR 1926.301
<b>Power-Operated Hand Tools</b> 29 CFR 1926.302	<b>Abrasive Wheels and Tools</b> 29 CFR 1926.303
<b>Woodworking Tools</b> 29 CFR 1926.304	<b>Jacks - Lever &amp; Ratchet, Screw and Hydraulic</b> 29 CFR 1926.305
<b>Air Receivers</b> 29 CFR 1926.306	<b>Mechanical Power-Transmission Apparatus</b> 29 CFR 1926.307

## The Tools Standard

---

Thousands of injuries occur because of the improper use of tools.

---

## Basic Safety Rules for Tools

- Use the right tool for the job.
- Examine the tool before use. Don't use a damaged tool.
- Operate tools according to the manufacturers' instructions.
- If a guard is required, use it.
- Use a Ground Fault Circuit Interrupter (GFCI) with electric tools.
- Wear the right personal protective equipment.
- Keep tools in good condition with regular inspection and maintenance.

## Hand Tools [29 CFR 1926.301]

---

Hand Tools are tools that don't have motors: axes, screwdrivers, hammers, chisels, scrapers, wrenches, etc.

Impact Tools: Wear safety glasses when using impact tools. A piece of metal can break off and strike your eye.

Wrenches: Wear work gloves if it's possible for the wrench to slip and injure your hand. Usually it's safer to pull a wrench rather than push it.

Wooden Handles: If the handle is cracked or loose, the head of the tool might fly off. Don't use it.

Sharpening: Dull tools cause more injuries than sharp ones.

Sparks: Steel hand tools can make sparks. Use spark-resistant tools around flammable liquids and gases.

Vises and clamps: Use a vise or clamp if necessary to hold the work securely. An insecure piece can cause the tool to slip, or cause you to lose your balance.

There are several types of power tools, based on the source of power:

- Electric
- Hydraulic
- Pneumatic (Air)
- Powder-actuated
- Liquid Fuel (Gasoline)

These safe work practices will reduce the dangers of using power tools:

- Never carry a tool by the cord or hose.
- Never yank the cord or the hose to disconnect the tool.
- Keep cords and hoses away from heat, oil, and sharp edges.
- Wear safety glasses.
- Disconnect the tool when changing blades, bits, and cutters.
- Keep and use guards and safety switches that are part of the tool.
- Hold work with clamps or a vise to free both hands to operate the tool.
- Maintain good footing and good balance.
- Dress for safety. Loose clothing or jewelry can catch in moving parts.
- Keep people not involved in the work at a safe distance.
- Disconnect tools when not using them.
- Keep tools in good condition.
- Remove damaged tools from use and tag them: "DO NOT USE."

## Power Tools

[29 CFR 1926.302]

---

The employer is responsible for the safe condition of tools and equipment used by employees. Employers shall not issue or permit the use of unsafe hand tools.

---

## Electric Tools

[29 CFR 1926.302(a)]

The most serious hazards of electric tools are shocks and electrical burns.

**Shocks:** Shock can cause injury and even heart failure. Under certain conditions, even a small amount of electric current can result in fibrillation of the heart and death. An electric shock also can cause the user to fall off of a ladder or elevated work surface and be injured due to the fall.

**Burns:** If an electric current arcs to your body it can also cause a severe burn. Remember that an electric arc is hot enough to weld steel.

**Protection:** To protect the user from shock and burns, electric tools must have one of the following arrangements:

- A three-wire cord with ground plugged into a grounded receptacle.
- A double insulated case.
- Be powered by a low-voltage isolation transformer.

**Grounding:** If you use an adapter in a two-hole receptacle, you must attach the adapter wire to a known ground. Never break off the third prong.

**Double Insulation:** Double-insulated tools are available that provide protection against electrical shock without third-wire grounding. On double-insulated tools, an internal layer of protective insulation completely isolates the external housing of the tool.



## Electric Tools

[29 CFR 1926.302(a)]

Follow these safe work practices when using electric tools:

- Operate electric tools within their design limitations.
- Use gloves and appropriate safety footwear when using electric tools.
- Store electric tools in a dry place when not in use.
- Do not use electric tools in damp or wet locations unless they are approved for that purpose.
- Keep work areas well lighted when operating electric tools.
- Ensure that cords from electric tools do not present a tripping hazard.

At a construction site the employer must provide one or the other of these systems to further protect workers from shock:

- Ground Fault Circuit Interrupters (GFCI) for every circuit that is not part of the permanent wiring of the building.
- An assured equipment grounding conductor program that assures proper grounding of every circuit that is not part of the permanent wiring of the building.

A GFCI will turn off the circuit if it senses a difference between the current “going” to a tool through the black wire and the current “returning” through the white wire. If the current is different, it might mean that some electricity is going through your body. The GFCI will cut the circuit and protect you.

---

See Module 3, “Electrical Safety,” for more information of GFCI’s and assured equipment grounding conductor programs.

---

## **Guards**

[29 CFR 1926.300(b)]

Hazardous moving parts of tools need guards in order to prevent accidental contact with blades, belts, gears, shafts, and pulleys. These parts should be guarded to the extent possible without preventing the proper use of the tool.

Most power tools come equipped with the proper guards. The tool is designed to be used with the guard in place. Don't decide that you know better than the engineer who designed the tool. Never remove a guard. If the tool can't do the job with the supplied guard in place, it may not be the right tool for the job.

Never remove or disable the retractable guard on a hand-held electric saw.

There are three types of switches that are used on power tools:

- Momentary (Only “ON” while pressure is applied.)
- Momentary with a LOCK-ON that releases with a single touch.
- Positive ON-OFF switch. (Stays “ON” until turned “OFF”.)

## Safe Switches

[29 CFR 1926.300(d)]

Safe Switches for Power Tools			
	Momentary ON-OFF	Momentary w/ LOCK-ON	Positive ON-OFF
Circular Saw Chain Saw Percussion Tool	Required	No	No
Drill Fastener Driver Belt Sander Reciprocating Saw Jig, Saber or Scroll Saw (blade bigger than ¼") Disk Sander (disk bigger than 2") Grinder (wheel bigger than 2")	OK	OK	No
Router Planer Laminate Trimmer Nibbler Shears Jig, Saber or Scroll Saw (blade ¼" or less) Disk Sander (disk 2" or less) Grinder (wheel 2" or less)	OK	OK	OK

## Abrasive Wheel Tools

[29 CFR 1926.303]

Abrasive wheel tools — like grinders and cutting wheels — create two special safety hazards:

- Pieces of the work being cut or ground can fly out.
- The abrasive wheel itself can shatter.

**Guards:** To protect flying pieces or a shattered wheel, there must be a guard that covers the spindle nut and at least one-half of the wheel. The fastenings must be strong enough that the guard will stay aligned with the wheel and will not come off during use. Do not remove the guard. If you can't do the work with the guard in place, then you might be using the wrong tool.

**Sound Test:** Before mounting an abrasive wheel, check it for cracks. Tap it gently with a piece of hard wood. An undamaged wheel will give a clear metallic ring. If the wheel sounds cracked or dead, discard it.

**Wheels:** Tighten the spindle nut enough to hold the wheel without distorting the flange. Follow the manufacturer's recommendations. Check to make sure that the operating speed of the tool is not faster than the maximum speed that the manufacturer specified for the wheel.

Allow the tool to reach operating speed before you start to grind or cut. Don't stand directly in front of the wheel as it comes up to speed. A defective wheel can shatter when it is first turned on.

Safe working procedures:

- Always wear safety glasses or a face shield.
- Never clamp a hand-held grinder in a vise.
- Turn off the power when not in use.

Pneumatic tools can create these special hazards:

- Getting hit by an attachment or fastener.
- Loud noise.
- Getting injured by air pressure.
- Muscle and joint injury (ergonomic injury).

**Hose:** Inspect the hose. Check that the hose and tool are securely connected. Make sure that the hose will not get damaged during use by rubbing against a sharp object, being burned or damaged by chemicals. Also make sure that it does not create a tripping hazard.

**Attachments:** Use a safety clip to secure an attachment — such as a chisel or chipping hammer — so that it cannot be ejected from the tool.

**Nails and staples:** A tool that drives nail, rivets or staples, must have a special device to keep fasteners from being ejected, unless the muzzle is pressed against the work surface.

**Ergonomics:** Vibrating tools, like jackhammers, can strain muscles and damage joints. Heavy rubber grips reduce these effects and provide a secure hand hold.

**Noise:** Many pneumatic tools make a very loud noise. Repeated exposure to loud noise will cause hearing loss. Hearing loss is irreversible.

Safe working procedures:

- Always wear safety glasses or a face shield.
- Never point an air gun toward anyone.
- Wear ear protection (ear plugs or ear muffs).

## Pneumatic Tools

[29 CFR 1926.302(b)]

---

If the hose is more than ½ inch in diameter, there must be a safety valve at the compressor. This is a good idea for smaller air hoses too.

---

## Liquid Fuel Tools

[29 CFR 1926.302(c)]

Fuel-powered tools, like chain saws, usually operate on gasoline. The special hazards with these tools are:

- Fire caused by flammable gasoline vapor.
- Toxic exhaust (carbon monoxide).
- Loud noise.

**Gasoline:** Gasoline is flammable. It has a very low flash point. This means that it gives off a lot of vapor. A spark, flame or other heat source can ignite the vapor. Keep gasoline in an approved container. When you transfer fuel from a larger tank or drum to a smaller container, bond the two containers together to prevent sparks that might ignite the vapor. Shut off the engine before refilling.

**Ventilation:** If you have to use a gasoline powered tool inside, make sure that there is sufficient ventilation to remove toxic exhaust.

**Confined Spaces:** Do not use liquid fuel tools in a confined space, or in any area with poor ventilation. These tools give off carbon monoxide, an odorless colorless gas that is deadly. Remember, that air-purifying respirators do not supply oxygen, and do not protect against carbon monoxide.

Safe working procedures:

- Always wear safety glasses or a face shield.
- Have a fire extinguisher nearby. (Class B, BC, or ABC — not Class A).
- Wear ear protection (ear plug or ear muffs).

Powder-actuated tools operate like a loaded gun. Only specially trained employees should use them.

**Powder:** Select a powder level — high or low velocity — that is appropriate for the tool and the job and does not create excessive force.

**Muzzle:** The muzzle of the tool must have a protective shield to catch fragments that are projected when the tool is fired.

**Safety:** The tool must not be able to operate until it is pressed against the work surface with a force of at least 5 pounds greater than the total weight of the tool.

**Misfire:** If a powder-actuated tool misfires, hold the tool in the operating position for at least 30 seconds before trying to fire it again. If it still will not fire, hold the tool in the operating position for another 30 seconds and then carefully remove the load in accordance with the manufacturer's instructions. This will make the faulty cartridge less likely to explode. Put the bad cartridge in water immediately.

Safe working procedures:

- Always wear safety glasses or a face shield.
- Inspect the tool before use.
- Only load the tool immediately before using.
- Never point the tool at anyone; this is no joke.
- Never leave a loaded tool unattended.
- Wear ear protection (ear plug or ear muffs).
- If the tool is damaged or defective, take it out of service immediately and tag it.

## Powder-Actuated Tools

[29 CFR 1926.302(e)]

Module

10

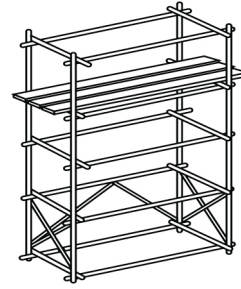

## Scaffolds

### Learning objectives

This module reviews hazards related to scaffold use at construction site. We discuss how to safely set-up, climb, work on, and descend scaffolds.

After completing this module you will be able to demonstrate your ability to:

1. IDENTIFY the work activities to which the OSHA Scaffolding Standard applies.
2. IDENTIFY the general requirements for scaffold capacity, platforms, access and use.
3. IDENTIFY the requirements for fall protection from scaffolds.
4. IDENTIFY the requirements for protection from objects falling from scaffolds.



Scaffolding is Subpart L of the OSHA Construction Standards. It contains five sections and five appendices. Each appendix contains information to assist employers and employees to comply with the Standard. The information in each appendix is “non-mandatory.” The appendix has methods that work, but the employer can use other methods as long as they comply with the standard.

**Scaffolding  
Standard**  
29 CFR 1926 Subpart L

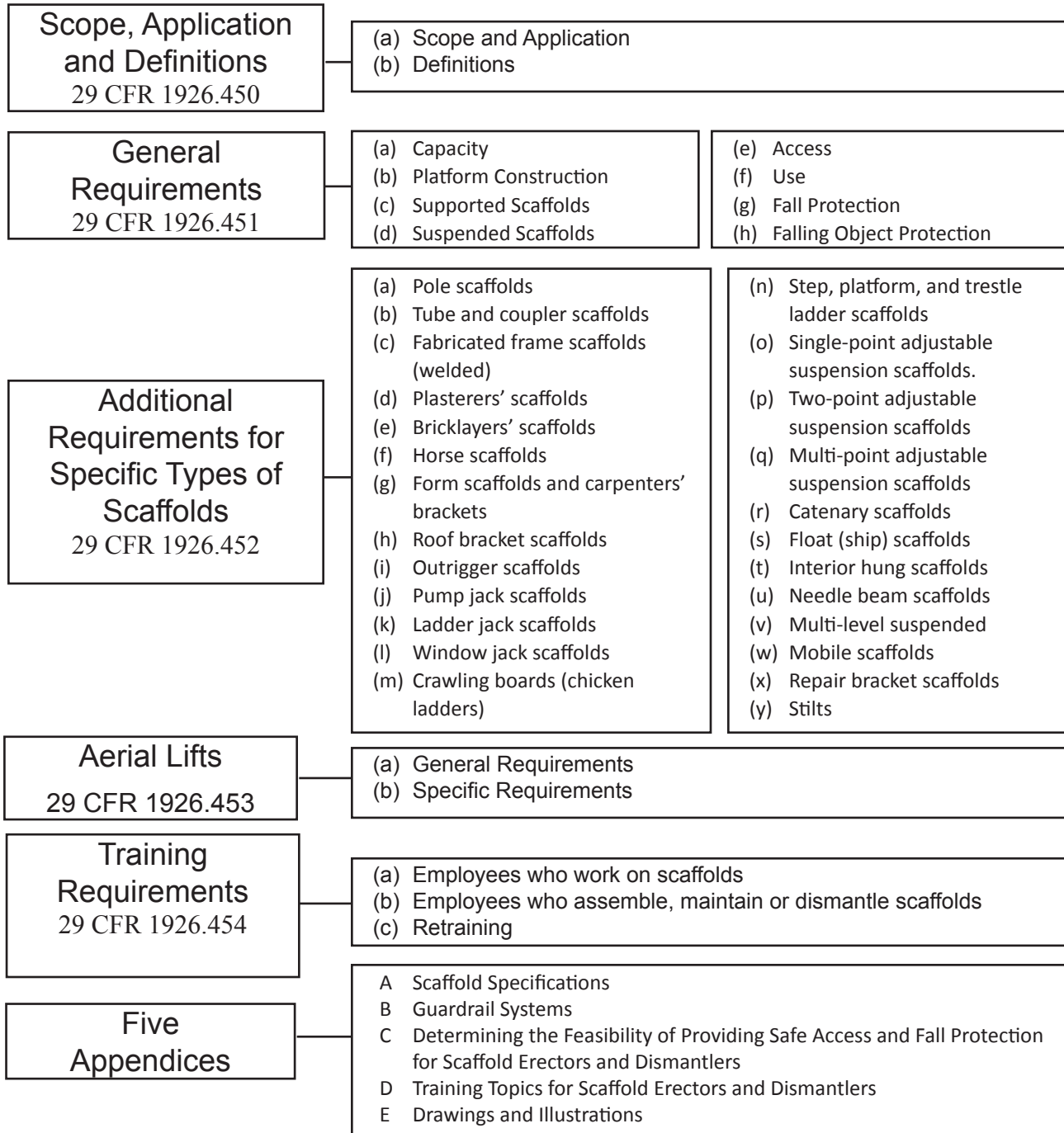

## Scaffold Are Hazardous

There are almost 10,000 accidents each year involving scaffolds, and approximately 80 worker deaths.

Most scaffold injuries result from:

- The employee slipping.
- The employee getting hit by a falling object.
- The planking or support giving way.

One out of four injured workers had no training about scaffold safety. Most of the rest only had informal on-the-job safety training.

Two out of three scaffolds where an accident occurred were missing a guard rail.

---

## In This Module

The OSHA Scaffolding Standard provides detailed requirements for 25 different types of scaffold. (Look back at items **(a)** through **(y)** in the middle of the previous page.) In this module we will discuss the following:

- General requirements.
- Common types of supported scaffolds:
  - Wooden pole scaffolds.
  - Tube and coupler scaffolds.
  - Tubular welded frame scaffolds.
  - Manually propelled mobile scaffolds.
  - Pump jack scaffolds.
  - Form scaffolds.
- Training requirements for workers who use scaffolds.

The OSHA Scaffolding Standard applies to all scaffolds used in

- Construction
- Demolition
- Alteration
- Repair (Includes Painting and Decorating)

Exception: Personnel platforms that hang from a crane or derrick are covered under the OSHA Crane and Derrick Standard.

OSHA lists definitions for all important terms used in the Standard. Especially important are the definitions of each type of scaffold. The definitions specify whether a particular scaffold is a “supported” or a “suspension scaffold.” This distinction is important since there are special safety rules for each type. In this module we discuss some common types of supported scaffold.

---

A qualified person must design every scaffold.

---

A scaffold must only be constructed and loaded the way that it was designed to be used.

A scaffold must not be loaded in excess of its capacity.

Every scaffold and scaffold component must be able to support, without failure, its own weight and at least 4 times the maximum intended load.

## **Scope, Application and Definitions**

[29 CFR 1926.450]

## **Scaffold Design**

[29 CFR 1926.451]

## **Scaffold Capacity**

[29 CFR 1926.451]

## Scaffold Platform Construction

[29 CFR 1926.451(b)]

All platforms must be fully decked or planked.

Exceptions:

1. Walkways only have to be two planks wide.
2. Platforms used only to erect or dismantle a scaffold only have to be as wide as the employer determines is necessary for safety.

The planks or units that make up the platform must be close together: no more than 1 inch between the planks.

Exception: A wider space is allowed between the planks if it's necessary because of the design of the scaffold. For example, if side brackets are used, then the scaffold uprights (which are bigger than 1 inch) are between the planks on the main part of the platform and the plank on the side brackets.

If the platform consists of separate planks, each plank must be at least a nominal 2 inches thick by 10 inches wide. (This is about 1½ by 9½ inches.)

There can be no more than 9½ inches between the planks and the scaffold uprights. If there is more than this space, then put in another plank.

Platforms must be at least 12 inches wide on ladder scaffolds and pump jack scaffolds.

There can be no more than 14 inches between the platform edge and the face of the structure, unless there is a guard rail system or personal fall arrest system.

The front edge of an outrigger scaffold must be no more than 3 inches from the structure. The front edge of a scaffold used for plastering and lathing must be no more than 18 inches from the face of the structure.

If a plank is 10 feet long or less, then it must stick out past its support at least 6 inches, but not more than 12 inches. If the plank is more than 10 feet long, it must stick out past its support at least 6 inches, but not more than 18 inches.

Planks do not have to overhang if they are securely fastened to their support.

Overlap platforms only on a support. There must be at least 12 inches of overlap.

Where a scaffold turns a corner, lay the planks that are on an angle first. Then lay the lengthwise planks on top.

Never paint the top and bottom surface of wood planking. The idea is to be able to see cracks and defects in the wood. The surface may be treated with a clear preservative and the ends may be painted.

Only modify parts to fit if a competent person determines that the change is structurally sound.

## Scaffold Platform Construction

[29 CFR 1926.451(b)]  
(Continued)

Planks overlap at least 12 inches and on top of a support.

Planks stick out at least 6 inches and no more than 12 inches.

They can extend 18 inches if the plank is more than 10 feet long.

Planks are close together.

The level where employees work is fully decked.

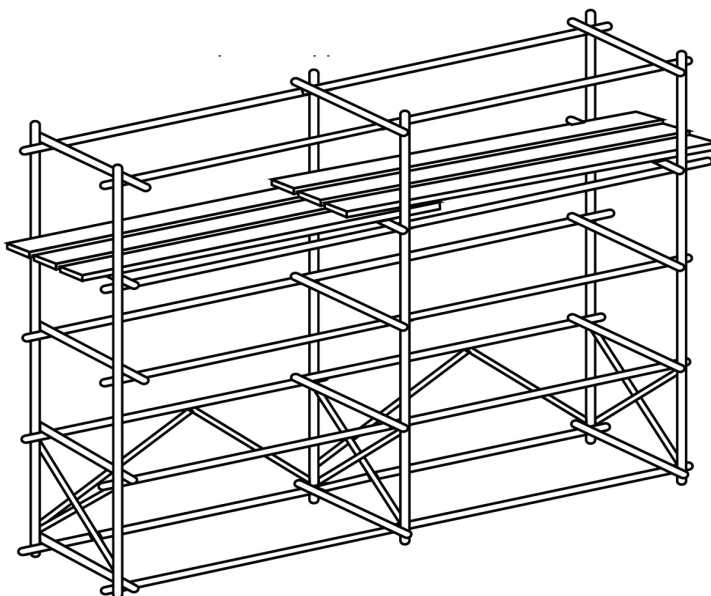

## **Make Sure It's Stable**

[29 CFR 1926.451(c)]

Make sure that the scaffold can't tip over: If its more than 4 times taller than it is wide (at the base), then the scaffold must be tied to the structure, or braced, or have guide wires so that it can't tip.

If the work platform sticks out in a way that makes the scaffold unbalanced, then there must also be ties, braces or guide wires.

The poles or legs must be plumb, and must rest on base plates or some other firm foundation that is level, rigid and strong enough to support the scaffold, workers and equipment.

## **Access**

[29 CFR 1926.451(e)]

How do you get to the work platform? There must be a ladder, stairs or ramp if the platform is more than 2 feet above (or below) the access point. "Access point" means the place where you are before you go to the work platform. The access point might be the ground, or it could be another work platform.

Cross braces don't count as a ladder and must not be used for access.

The ladder, stairs or ramp must be strong and secure. It may be an integral part of the scaffold. It should not cause the scaffold to tip.

If a ramp has a rise to run ratio greater than 1 to 8, then it must have cleats to help prevent workers from slipping. No ramp shall be steeper than 1 to 3.

How do you get up and down a scaffold while you are erecting it or taking it down? OSHA says that a competent person shall determine how workers who are erecting or dismantling a scaffold will gain access.

A **competent person** must supervise the erection, moving, dismantling or altering of any scaffold. The competent person must select experienced and trained employees to do this work.

A competent person must inspect each scaffold prior to each work shift.

The competent person must also inspect the scaffold after any occurrence that might have affected the scaffold's structural integrity.

---

Keep the scaffold clear of electric power lines:

- At least 3 feet away from an insulated line under 300 volts.
  - At least 10 feet away from an insulated line over 300 volts.
  - At least 10 feet away from any non-insulated line.
- 

No work is allowed on a scaffold covered with snow or ice until it is removed.

No work is allowed on a scaffold during high winds unless a competent person determines that it is safe to work.

## **A Competent Person Must Supervise**

[29 CFR 1926.451(f)]

## **Keep Clear of Electric Lines**

[29 CFR 1926.451(f)]

## **Adverse Weather**

[29 CFR 1926.451(f)]

## Work Safely

[29 CFR 1926.451(f)]

Never stand on a box or other makeshift item to reach higher from than the platform.

The planks must not deflect more than 1/60 of their length. This means that the greatest deflection allowed in a 10 foot long plank is 2 inches. If it bends more than this, replace it with a stronger plank.

Never move a scaffold with workers on it, unless the scaffold has been designed by a registered professional engineer specifically to be moved while occupied.

## Fall Protection

[29 CFR 1926.451(g)]

---

**10 foot threshold:** There must be fall protection for workers on a scaffold where the work platform is more than 10 feet up.

This is different than the 6 foot requirement for other walking and working surfaces in the OSHA Fall Protection Standard.

**State Standards:** Some states have lower thresholds. Make sure that you know the requirement in your state.

**Guardrails:** Wood pole scaffolds, tube & connector scaffolds, and welded frame scaffolds must all have guardrails on all sides.

Guardrails must be made of 2x4's or an equivalent material, and must be approximately 42 inches above the work platform (38 to 45 inches).

Guardrails must not have splinters, nails or other hazards.



**Exception for bricklaying:** For employees doing overhand bricklaying, it is not required to have a guardrail on the side facing the work.

**Walkways:** A walkway that is used to get from one scaffold platform to another (and is not used for working) only needs a guardrail on one side.

**Erecting and dismantling:** It might be hard to figure out how to have fall protection for workers who erect or dismantle scaffolding. Often a personal fall arrest system (for example, a life line and lanyard) will work.

OSHA says that the employer must figure out how to provide fall protection for workers who erect or dismantle a scaffold, if possible. There must be a valid reason if the employer decides not to provide fall protection to these workers.

---

**Hard hats:** Employees who work on or around scaffolds shall wear hard hats.

**Toe boards:** The scaffold must have toe boards or some other means to prevent tools, materials and debris from falling on workers below. Alternatives to toe boards include screens, debris nets, catch platforms and canopies.

Toe boards shall be at least 3½ inches tall and allow no more than a ¼ inch space between the toe board and the work surface.

If an object on the scaffold is too big or heavy for the toe board to keep it from falling off, then it must be kept away from the edge and secured if possible.

**Barricades:** The employer can put up barricades to keep workers from areas where falling objects might land.

## Fall Protection

(Continued)

[29 CFR 1926.451(g)]

## Protection from Falling Objects

[29 CFR 1926.451(h)]

## Wood Pole Scaffolds

[29 CFR 1926.452(a)]

The general requirements discussed earlier apply to wood pole scaffolds.

The poles which hold up the scaffold shall be plumb and shall rest on a firm foundation or base plate.

If the poles are spliced, they must be cut square and the upper section shall rest directly on the lower section. There must be splice plates on at least two adjacent sides. The plates must extend at least 2 feet in either direction from the splice.

There must be adequate diagonal and cross bracing.

Never splice ledgers (the long, horizontal pieces) between poles.

A wood pole scaffold taller than 60 feet must be designed by a registered professional engineer.

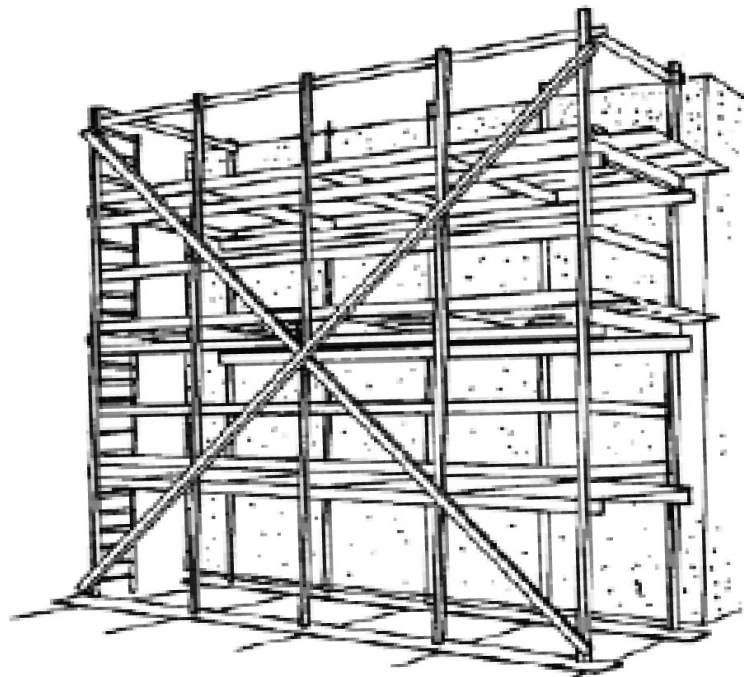

Wood Pole Scaffold

It is very important that tube and coupler scaffolds be erected correctly, using the proper couplers and braces, and with the proper spacing and attachments.

**Tubing:** Posts, bearers, runners and bracing must be made of steel tubing 2 inch outside diameter - or larger.

**Posts:** Posts must be accurately spaced, plumb, and rest on suitable bases.

Maximum Post Spacing	Light Duty	Medium Duty	Heavy Duty
Front to Back:	6 feet	5 feet *	4 feet
Along the Length:	10 feet	8 feet	6 feet 6 inches
(*May be 6 feet front to back if bearers are 2½ O.D.)			

**Runners:** Runners must be coupled to each post. Bottom runners as close to the base as possible.

**Bearers:** Must be coupled to the posts, or to the runners close to the posts. Bearers must be between 4 to 12 inches longer than the post spacing or runner spacing.

**Cross Bracing:** At least every third set of posts horizontally and every fourth runner vertically.

**Longitudinal Diagonal Bracing:** Approximately 45 degree angle. Brace inner and outer rows of posts in both directions. Repeat every fifth set of posts. (The illustration only shows the longitudinal diagonal bracing in one direction.)

**Attachment to the Building:** Brace and tie the scaffold securely to the building at least every 30 feet horizontally and 26 feet vertically.

## Tube and Coupler Scaffolds

[29 CFR 1926.452(b)]

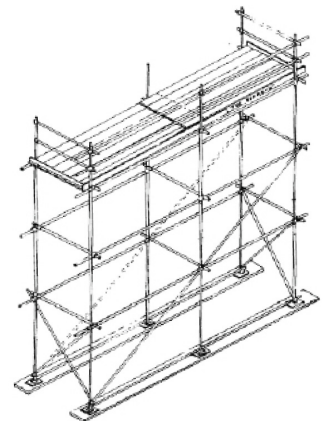

Tube and Coupler Scaffold

# Tubular Welded Frame Scaffolds

[29 CFR 1926.452(c)]

**Bases:** Scaffold legs must rest on adjustable or plain bases that are placed on a foundation that can support the maximum load on the scaffold.

**Attachment to the Building:** Brace and tie the scaffold securely to the building at least every 30 feet horizontally and 26 feet vertically.

**Cross and Diagonal Bracing:** The bracing must be attached so that it squares and aligns the vertical members so that the scaffold is plumb, square and rigid.

**Uplift Protection:** If part of the scaffold might be accidentally lifted, then the vertical members must have pins to lock them together so they can't separate.

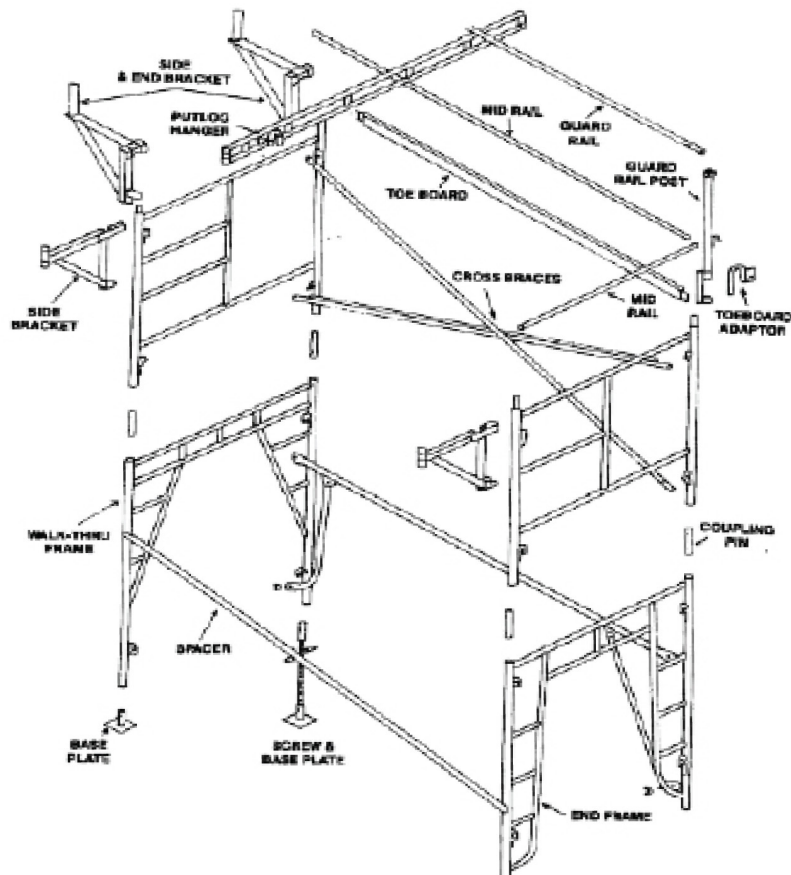

Tubular Welded Frame Scaffold

**Height:** A freestanding mobile scaffold must be no more than four times as high as it is long.

**Casters:** These must be strong enough to support four times the load on them. Each caster must have a positive locking device.

**Ladder or Stair:** A ladder or stair must be built into the scaffold or firmly attached. The ladder or stair must be located so that when workers climb it they do not tip the scaffold.

**Moving:** Move the scaffold only on level surfaces free of holes or obstructions. Apply force as low as possible so the scaffold won't tip.

**Riding:** Workers may be on the scaffold when it is moved only if all of the following conditions exist:

- The floor is within 3 degrees of level and free from pits, holes or obstructions.
- The minimum dimension of the base is at least one half the height.
- All tools and materials are removed or firmly secured.

**Plumb and Secure:** Before workers ascend the scaffold, it must be on a suitable footing. It must be plumb, and the casters must be locked.

## Manually Propelled Mobile Scaffolds

[29 CFR 1926.452(w)]

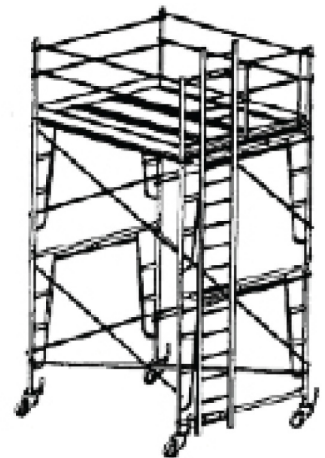

Manually propelled  
mobile scaffolds

## Pump Jack Scaffolds

[29 CFR 1926.452(j)]

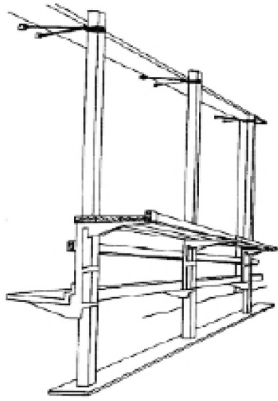

## Scaffolds for Concrete Forms

[29 CFR 1926.452(g)]

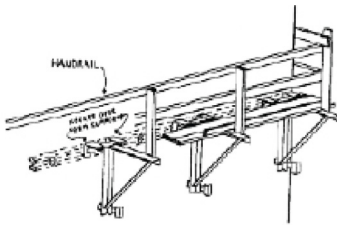

Form scaffold

**Maximum Load:** 500 lbs. total weight of workers, tools and materials between any two poles. No more than two workers between any two poles.

**Prevent Slipping:** Each jack bracket must have two positive gripping mechanisms to prevent slipping.

**Poles:** Poles must be two 2 inch by 4 inch pieces of clear, straight grained wood. Poles must not be more than 30 feet high and not more than 10 feet apart.

**Planking:** Planks must be secured. Connect or overlap planks only on a bracket.

---

**Planking:** Planks must be secured to the brackets, or they must overlap by at least six inches. Only join or overlap planks at a bracket.

**Span:** No more than 8 feet between brackets.

**Figure-Four Form Scaffolds:** The outrigger ledger must be made of two pieces of 1 inch by 6 inch (or heavier) wood nailed on both sides of the vertical form support. The ledger can be no more than 42 inches long. There must be a 45 degree angle brace that intersects the ledger at least 3 feet from the form.

**Metal Bracket Form Scaffolds:** The brackets must be an integral part of the form, or they must be securely bolted or pinned to the form. It's OK to use "hook-over" brackets if they hang from form walers, and if the walers are securely anchored to the form or secured to the shear bolts.

**Wooden Bracket Form Scaffolds:** The brackets must be an integral part of the form panels.

**Lift controls.** Test lift controls each day prior to use.

**Authorized Operators.** Only authorized persons can operate an aerial lift.

**Body Harnesses.** A worker in an aerial lift must have a body harness with a lanyard attached to the boom or basket. Never tie off to an adjacent pole or structure.

**Stance.** Stand firmly on the floor of the basket. Never sit or climb on the edge of the basket or use planks, ladders, or other devices for a work position.

**Load Limits.** Never exceed the boom and basket load limits specified by the manufacturer.

**Brakes and Chocks.** Set the brakes and place wheel chocks.

**Outriggers.** If outriggers are used, position them on pads or on a solid surface.

**Movement.** Never move an aerial lift truck with the boom elevated and a worker in the basket, except when the equipment is specifically designed for this type of operation.

**Controls.** There must be a lower set of controls (at the truck) and an upper set (at the platform or basket).

Lower controls must provide for overriding the upper controls. However, never operate the lower level controls without permission from the employee in the lift, except in case of emergency.

**Insulation.** The insulated portion of an aerial lift shall not be altered in any manner that might reduce its insulating value.



## More Scaffold Types

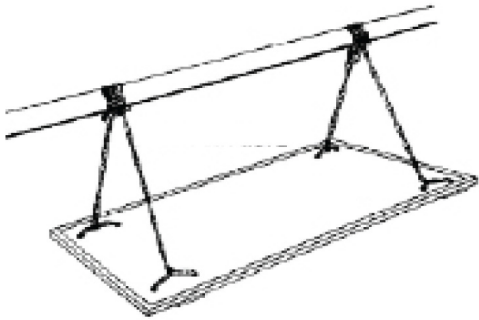

Float Scaffold

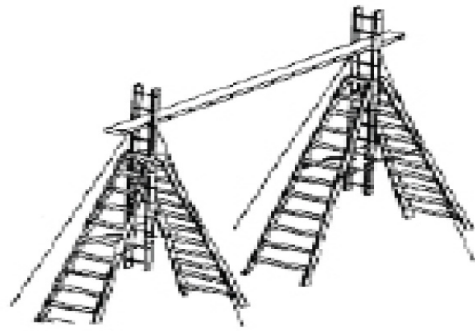

Extension Trestle Scaffold

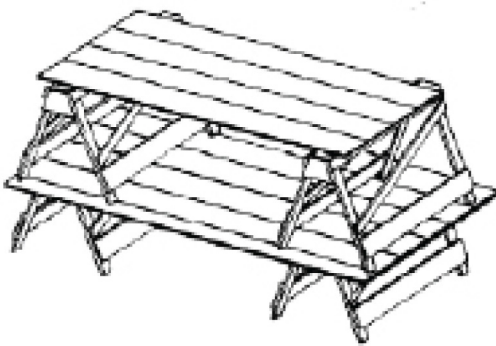

Horse Scaffold

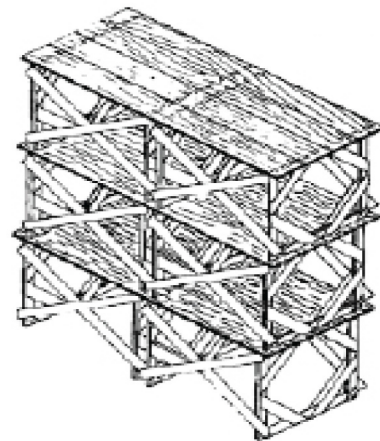

Bricklayer's Square Scaffold

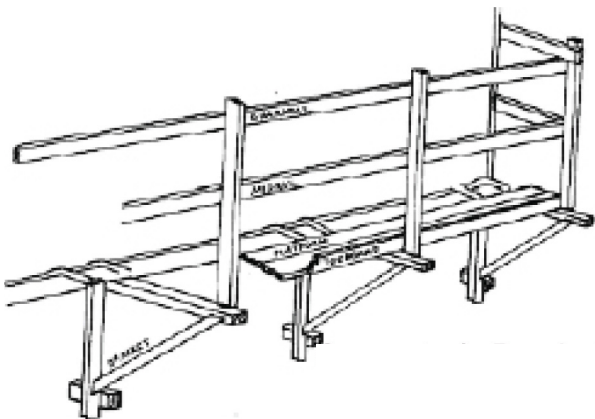

Carpenter's Bracket Scaffold

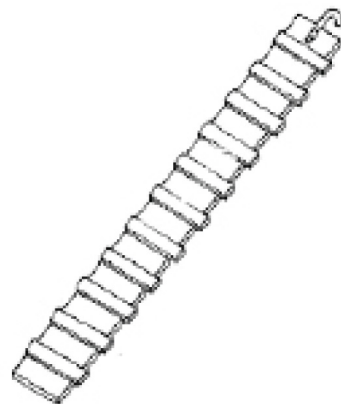

Chicken Board



## More Scaffold Types

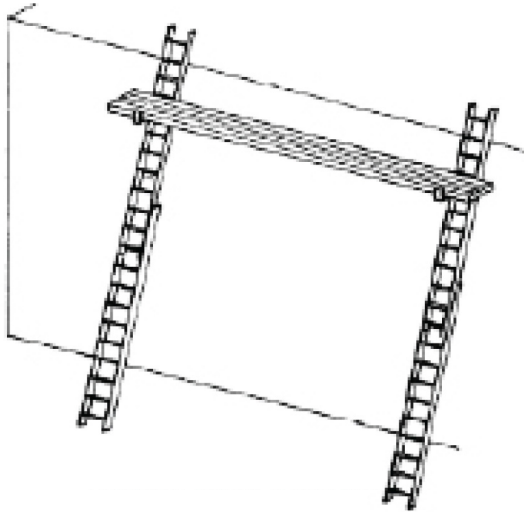

Ladder Jack Scaffold

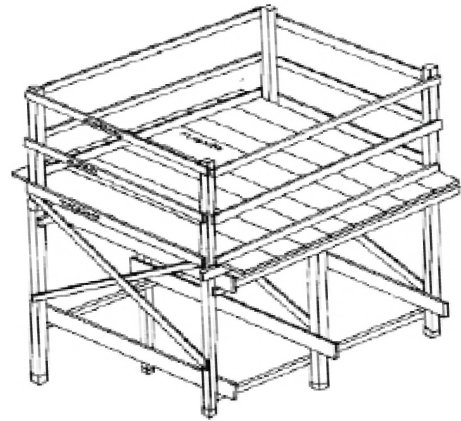

Plaster's Scaffold

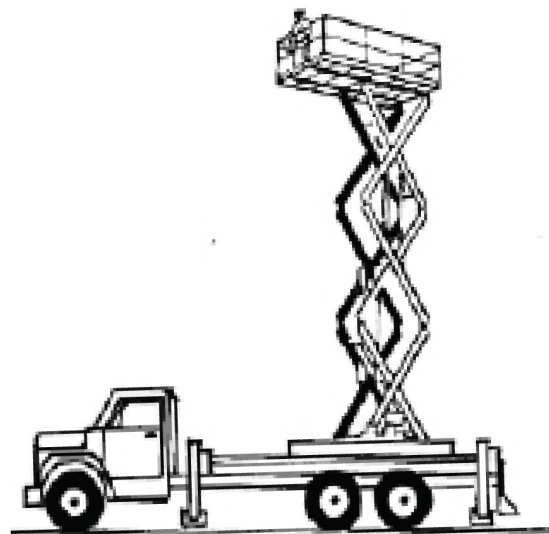
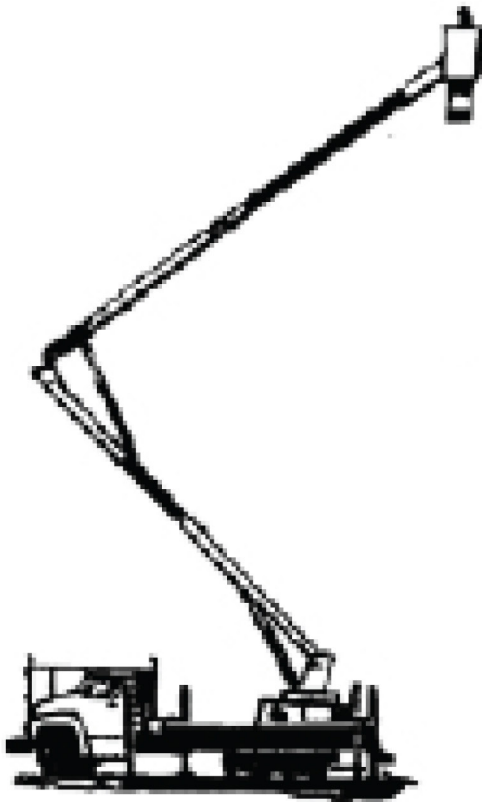

Aerial Lifts

## More Scaffold Types

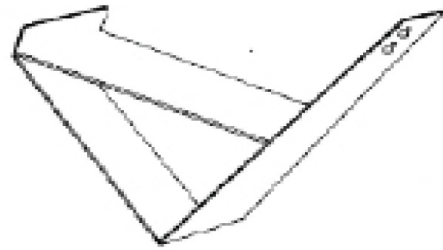
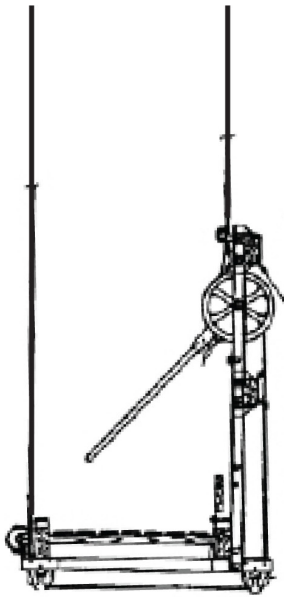

Roofing Bracket

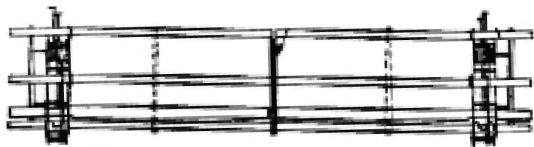

Multi-Point Suspension Scaffold



Boatswain's Chair

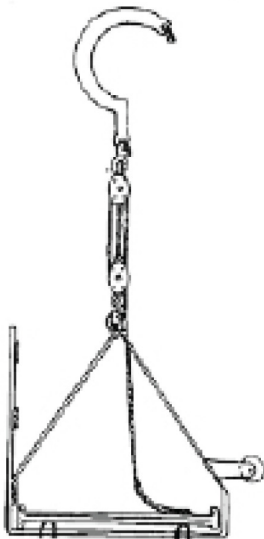

Swinging Scaffold

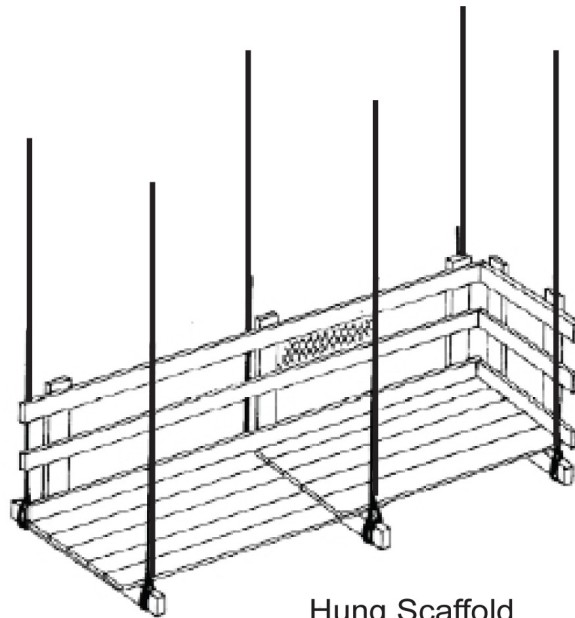

Hung Scaffold

- notes -

Module

11

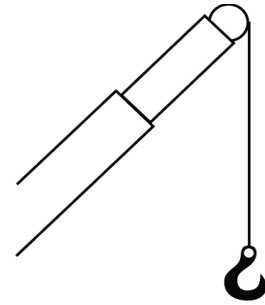

# Cranes, Derricks, Hoists, Elevators and Conveyors

## Learning objectives

This Module reviews the hazards associated with the use of cranes, derricks and hoists at construction sites, and reviews safe work practices.

After completing this Module you will be able to demonstrate your ability to:

1. IDENTIFY how to determine the safe capacity of a crane or derrick.
2. IDENTIFY when cranes and hoists must be inspected and tested.
3. IDENTIFY when wire rope must be taken out of service on a crane or hoist.
4. IDENTIFY the conditions in which a personnel platform suspended from a crane or derrick may be used.
5. IDENTIFY when a pre-lift meeting is required

**Cranes, Derricks, Hoists, Elevators and Conveyors**, is Subpart N of the OSHA Construction Standard. It has six sections shown in the boxes below. In this module we focus on cranes, derricks and hoists.

Approximately 80 workers die in crane accidents each year. The major causes of crane accidents are:

- Contact with power lines.
- Overturning.
- Rigging failure.
- Dropped loads.
- Improper use of outriggers.
- Boom collapse.
- Improper use of lifting devices.
- Crushed by counterweights.

**Cranes and Derricks**  
29 CFR 1926.550

**Helicopters**  
29 CFR 1926.551

**Hoists and Elevators**  
29 CFR 1926.552

**Base Mounted Drum  
Hoists**  
29 CFR 1926.553

**Overhead Hoists**  
29 CFR 1926.554

**Conveyors**  
29 CFR 1926.555

## **Cranes, Derricks, Etc.**

29 CFR 1926 Subpart N

---

Often cranes are not properly maintained and inspected.

Many cranes are operated by workers who do not have the necessary qualifications.

---

# Cranes and Derricks: General Requirements

[29 CFR 1926.550(a)]

**Specifications and Limitations.** Equipment must be operated according to the manufacturer's specifications and limitations. Attachments must not exceed the rated load capacity.

**Signals.** Workers must use the appropriate ANSI hand signals. A copy of the signals must be posted on the site.

**Pre-Shift Inspections.** A competent person must inspect all machinery and equipment prior to each use to make sure it is in safe operating condition. Any deficiencies must be repaired before continued use.

**Annual Inspections.** At least once a year a competent person must conduct a thorough inspection. The employer must keep a record of the dates and results of inspections.

Defective Wire Running Rope must be taken out of service if any of the following conditions exist:

- Six randomly distributed broken wires in one lay.
- Three broken wires in one strand in one lay.
- Wear of one-third the original diameter of outside individual wires.
- Kinking, crushing, bird caging, or distortion.
- Heat damage.
- Reduction in the nominal diameter.

Defective Wire Standing Rope must be taken out of service if any of the following conditions exist:

- More than two broken wires in one lay beyond the end connections.
- More than one broken wire at an end connection.

## **Cranes and Derricks: General Requirements**

[29 CFR 1926.550(a)]

(Continued)

**Modifications.** No modifications or additions which affect the capacity or safe operation of the equipment shall be made without the manufacturer's written approval. In no case shall the original safety factor of the equipment be reduced.

**Guarding.** Belts, gears, shafts, pulleys, drums, fly wheels, chains, or other moving parts or equipment must be guarded to protect employees from contact.

The swing radius of the rear of the rotating superstructure of the crane must be barricaded to prevent an employee from being struck or crushed by the crane.

Exhaust pipes must be guarded or insulated if workers might contact them.

**Safety Glass.** Cab windows must be made of safety glass, or equivalent, that causes no visible distortion that would interfere with safe operation of the machine.

**Walking Surfaces.** Platforms and walkways must have anti-skid surfaces.

**Fire Extinguisher.** There must be a fire extinguisher accessible to the cab or operating station. This must be a 5BC rating, or higher.

**Nearby Workers.** Employees must keep clear of loads about to be lifted and clear of suspended loads.

## Clearance from Power Lines

[29 CFR 1926.550(a)]

Operate cranes near a power line only if:

- The power line is de-energized and visibly grounded; or
- Insulated barriers are in place to prevent contact; or
- Sufficient clearance is maintained as shown in the box below.

### Required clearance while working:

50,000 volts (50kV) or less	10 feet
More than 50,000 volts (50kV)	10 feet plus 0.4 inch for each 1 kV over 50 kV

### Required clearance while moving the crane without a load and with the boom lowered

50,000 volts (50kV) or less	4 feet
More than 50kV, less than 345 kV	10 feet
More than 345 kV up to 750 kV	16 feet

**Spotter.** If it is difficult for the operator to see the power line, then there must be a person designated to watch the clearance and to warn the operator.

Assume it's alive. Any overhead wire must be considered to be energized until:

1. The utility company or the person owning the line states that it is not energized,  
-and-
2. The line has been visibly grounded.



Using a crane to lift people is very dangerous.

**No Safe Alternative.** The OSHA standard prohibits hoisting personnel by crane or derrick except when no safe alternative is possible. Using a crane or derrick to hoist people is only allowed if conventional means of transporting employees (for example, ladders or personnel hoists) are not feasible or unless they present greater hazards.

**On the Level.** A crane or derrick used to lift people must rest on a horizontal surface that is within 1 percent of a level grade.

**Operation.** The operator must always be at the controls when the crane engine is running and the personnel platform is occupied.

Any movement of the personnel platform must be performed slowly and cautiously without any sudden jerking.

When the platform is in a stationary position, all brakes and locking devices on the crane or derrick must be set.

**Wire Rope.** The wire rope used for personnel lifting must have a safety factor of at least seven. This means that it can support seven times the maximum intended load. If rotation resistant rope is used, it must have a safety factor of at least ten.

**Crane Capacity.** The combined weight of the loaded personnel platform and its rigging must not exceed 50 percent of the rated capacity of the crane or derrick for the radius and configuration.

Cranes and derricks also must be equipped with an anti-two-block device.

## Personnel Platforms

[29 CFR 1926.550(g)]  
(Continued)

**Instruments and Components.** If there is a variable angle boom, then there must be a boom angle indicator that is visible to the operator. Cranes with telescoping booms must have a device to clearly indicate the boom's extended length, or an accurate determination of the load radius to be used during the lift must be made prior to hoisting personnel.

**Personnel Platforms.** A platform used for lifting personnel must be designed by a qualified engineer or a qualified person competent in structural design. The platform must have a safety factor of at least five. The suspension system must be designed to minimize tipping due to personnel movement on the platform.

The platform must have a standard guardrail system that is enclosed from the toe board to the mid-rail to keep tools, materials, and equipment from falling on employees below.

The platform also must have an inside grab rail, adequate headroom for employees, and a plate or other permanent marking that clearly indicates the platform's weight and rated load capacity.

If personnel might be exposed to falling objects, overhead protection on the platform and the use of hard hats are required.

The access gate must have a restraining device to prevent accidental opening.

All welding on the personnel platform and its components must be performed by a qualified welder who is familiar with weld grades, types, and materials specified in the platform design.

**Loading.** The personnel platform must not be loaded in excess of its rated load capacity or its maximum intended load.

Only personnel instructed in the requirements of this standard and the task to be performed — along with their tools, equipment, and materials needed for the job — are allowed on the platform. Materials and tools must be secured and evenly distributed to balance the load while the platform is in motion.

**Rigging.** Bridles and associated rigging for attaching the personnel platform to the hoist line must not be used for any other purpose.

Hooks must be closed and locked, or a shackle with bolt, nut, and retaining pin may be used.

**Pre-Lift Meeting.** The employer must hold a pre-lift meeting with all workers involved (operator, signal person(s), foreman, and the workers to be lifted) to review the procedures. This meeting must be held before the trial lift at each new work site and must be repeated for any new employees in the operation.

## Personnel Platforms

[29 CFR 1926.550(g)]

(Continued)

---

“Mousing” (wrapping wire around a hook to cover the hook opening) is not permitted in place of a locking hook.

---

## Personnel

### Platforms

[29 CFR 1926.550(g)]

(Continued)

**Before employees are hoisted.** Check the following:

- Hoist ropes are free of kinks.
- Multiple part lines not twisted around each other.
- Primary attachment centered over the platform.
- There is no slack in the wire rope.
- All ropes properly seated on drums and sheaves.

**Safe Work Practices.** Follow these safe work practices:

- Use tag lines unless their use creates an unsafe condition.
- Keep all parts of the body inside the platform.
- Make sure a platform is secured to the structure where work is to be performed before entering or exiting.
- Wear a body harness with a lanyard. Attach the lanyard to the lower load block or overhaul ball, or to a structural part of the platform.
- Stay in view, or in direct communication with the operator or signal person.

**Crane and derrick operators.** Follow these safe work practices:

- Never leave the controls with the engine running or the platform occupied.
- Don't operate if there are indications of dangerous weather conditions.
- Do not make any lifts on another load line of a crane or derrick that is being used to hoist personnel.

**Inspecting and Testing.** A trial lift of the unoccupied personnel platform must be made before any employees are hoisted.

**Dummy Weight.** During the trial lift, the personnel platform must be loaded at least to its anticipated lift weight.

The lift must start at ground level or at the location where employees will enter the platform and proceed to each location where the personnel platform is to be hoisted and positioned. The trial lift must be performed immediately prior to placing personnel on the platform.

The operator must check all systems, controls, and safety devices to ensure the following:

- They are functioning properly.
- There are no interferences.
- All boom or hoisting configurations necessary to reach work locations will allow the operator to remain within the 50 percent load limit of the hoist's rated capacity.

If a crane or derrick is moved to a new location, the trial lift must be repeated before hoisting personnel.

After the trial lift, the personnel platform must be hoisted a few inches and inspected to ensure that it remains secured and is properly balanced. A thorough visual inspection of the crane, the personnel platform, and the base support or ground must be conducted by a competent person to determine if the trial lift exposed any defects or produced any adverse effects. Any defects found during inspections must be corrected before hoisting personnel.

## Personnel

### Platforms

[29 CFR 1926.550(g)]

(Continued)

**Moving the Crane.** Personnel hoisting is prohibited while the crane is traveling except when the employer demonstrates that this is the least hazardous way to accomplish the task, or when portal, tower, or locomotive cranes are used.

- Travel must be restricted to a fixed track or runway.
- Travel must be limited to the radius of the boom during the lift.
- The boom must be parallel to the direction of travel.
- There must be a complete trial run before workers occupy the platform.
- If the crane has rubber tires, the condition and air pressure of the tires must be checked.

## Tower Cranes

[29 CFR 1926.550(c)]

**Clearance for Employees.** There must be clearance between the moving or rotating parts and fixed objects to allow the passage of employees without harm.

**Work on the Boom.** If an employee must work on the horizontal boom of a tower crane, then the boom must have a guardrail or a personal fall arrest system. This equipment is described more fully in the Fall Protection Module.

**Hoist Limitations and Capacities:** The employer must comply with the manufacturer's specifications and limitations. If these are not available, then a professional engineer, competent in the field, must determine the limitations and specifications in writing.

The rated load capacities, operating speeds and special hazard warnings must be posted on cars and platforms.

**Wire Rope.** Wire rope must be taken out of service if any of the following conditions exist in hoisting ropes:

- Six randomly distributed broken wires in one lay.
- Three broken wires in one strand in one lay.
- Wear of one-third the original diameter of outside individual wires.
- Kinking, crushing, bird caging, or distortion of the rope structure.
- Heat damage (for example from contact with a cutting torch or arc).
- Reduction in the nominal diameter.

---

**Postings.** Operating rules, including signals and line speeds must be posted at the operator's station.

**Not for Personnel.** No person shall be allowed to ride on material hoists except for the purposes of inspection and maintenance.

**Entrances.** The entrances to the hoist must have substantial gates or bars across the full width of the entrance. Bars and gates must be painted with diagonal contrasting colors, such as black and yellow stripes.

## Hoists: General Requirements

[29 CFR 1926.552]

## Material Hoists

[29 CFR 1926.552]

## Material Hoists

[29 CFR 1926.552]

(Continued)

**Gates.** The entrance bars must be at least 2- by 4-inch wooden bars or the equivalent, located 2 feet from the hoist way line. They must be located between 36 inches and 42 inches above the floor.

Gates or bars at entrances must have a latching device.

**Overhead Protective Covering.** There must be 2-inch planking,  $\frac{3}{4}$  inch plywood, or other solid material on the top of a material hoist cage or platform.

The operator's station must have overhead protection equivalent to tight planking at least 2 inches thick.

**Hoist Towers.** The tower may be enclosed, or not enclosed, as follows:

An enclosed tower must be enclosed on all sides for its entire height with a screen enclosure of  $\frac{1}{2}$  inch mesh wire, except for landing access.

When a hoist tower is not enclosed, the hoist platform or car must be totally enclosed (caged) on all sides for the full height between the floor and the overhead protective covering with  $\frac{1}{2}$  inch mesh wire or equivalent.

**Car Arresting Devices.** There must be car arresting devices in case the rope fails.

**Design.** Material hoist towers must be designed by a licensed professional engineer.

**Booms.** The installation of live booms on hoists is prohibited.



**Endless Belt Hoists.** The use of endless belt man lifts is prohibited.

**Enclosure.** Hoist towers outside the structure must be enclosed for the full height on the side or sides used for entrance and exit.

**At the Lowest Landing.** The sides not used for exit or entrance must also be enclosed to height of at least 10 feet. Other sides of the tower adjacent to floors or scaffold platforms must be enclosed to a height of 10 feet above the level of such floors or scaffolds.

Towers inside of structures must be enclosed on all four sides throughout the full height.

**Anchoring.** Towers must be anchored to the structure at least once every 25 feet. In addition, there must be a system of guide wires of at least one-half inch in diameter wire rope.

**Doors and Gates.** Doors and gates must be at least 6 feet 6 inches high and must have mechanical locks which cannot be operated from the landing side.

Doors or gates must have electric contacts which prevent movement of the hoist when the door or gate is open.

**Cars.** Cars must be permanently enclosed on all sides and the top, except for the entrance and exit which have gates or doors.

The car must have a data plate in a conspicuous place showing its capacity.

## Personnel Hoists

[29 CFR 1926.552

## Personnel Hoists

[29 CFR 1926.552]

(Continued)

**Overhead Protective Covering.** There must be 2 inch planking,  $\frac{3}{4}$  inch plywood or other solid material on the top of every personnel hoist.

**Car Arresting Devices.** There must be car arresting devices capable of stopping and holding the car at the rated load.

**Emergency Stop Switch.** There must be an emergency stop switch in the car.

**Hoisting Ropes.** There must be at least three hoisting ropes for traction hoists and two for drum-type hoists. The minimum diameter of hoisting and counterweight wire ropes is  $\frac{1}{2}$  inch wire rope.

**Inspections and Tests.** After assembly of the hoist, and before being put in service, there must be an inspection and test of all functions and safety devices under the supervision of a competent person. A similar inspection and test is required following major alteration of an existing installation.

Personnel hoists must be inspected and tested at least once every 3 months. The employer must prepare a written certificate showing who did the test, and when. The most recent certification record must be kept on file.

- notes -

Module

12

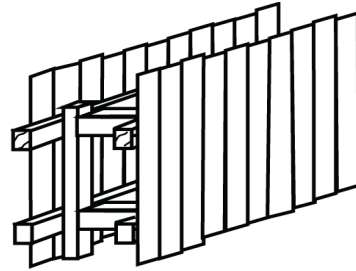

## Excavations

### Learning objectives

This Module discusses the hazards associated with excavations and trenches.

After completing this module you will be able to demonstrate your ability to:

1. IDENTIFY the steps that must be taken before excavation work begins.
2. IDENTIFY the general safety requirements for excavation work.
3. IDENTIFY the two main types of protective systems for excavations and trenches.
4. IDENTIFY the depth of an excavation that requires a protective system.
5. IDENTIFY the responsibilities of a competent person with regard to excavation and trenching work.
6. DEFINE excavation and trench.

Excavations is Subpart P of the OSHA Construction Standards. It has three sections and six appendices, as shown in the boxes below.



## Excavations

[29 CFR 1926 Subpart P]

This subpart applies to all open excavations made in the earth's surface, including trenches.

**Excavation** means any man-made cut, cavity, trench, or depression in an earth surface, formed by earth removal.

**Trench** means an excavation that is 15 feet or less wide, and is longer than it is wide.

## Scope and Application

[29 CFR 1926.650]

## Plan Before You Dig

[29 CFR 1926.651]

Many excavation accidents result from a failure to plan the excavation work correctly. Proper investigation and preparation of the site takes time. The contractor should build safety into the pre-bid plan.

It is important, before digging starts, to:

- Locate underground utilities. Sewer, water, telephone, fuel, electric, cable TV, etc. Contact local utility companies so they can identify where their lines are, or call the local locate service.
- Identify nearby underground storage tanks, pipe lines or sewers that could leak toxic or flammable materials into the excavation.
- Determine the type of soil.
- Remove or support objects and structures near the excavation.
- Identify overhead structures and utilities that might be a hazard during excavation work.
- Determine whether traffic near the excavation will cause a hazard.
- Locate nearby sources of surface water that might run into the excavation.
- Determine the depth of the water table. Will underground water cause flooding?
- Consider the weather that might occur while the work takes place.

Any trench 4 feet or more deep must have a stairway, ladder or ramp for workers. These must be located so that a worker never has to go more than 25 feet along the trench to get out. In other words, ladders, stairways and ramps can be no more than 50 feet apart.

---

No employee is permitted underneath loads handled by lifting or digging equipment. Employees must stand away from a vehicle being loaded or unloaded to avoid being struck by falling materials. A driver may remain in the cab, if the vehicle is equipped to provide protection during loading and unloading.

---

When mobile equipment is operated near an excavation, or when such equipment needs to approach the edge of an excavation, and the operator does not have a clear and direct view of the edge, then there must be a warning system. This can be barricades, hand or mechanical signals, or stop logs. If possible, the grade should be away from the excavation.

---

If the excavation is 4 feet or more deep, and there is the possibility of hazardous gases or vapor entering, or the possibility of oxygen deficiency, then OSHA requires the air in the excavation to be monitored. This might include measuring the oxygen level, determining the concentration of toxic gases and vapors, and measuring whether the level of flammable gases and vapors is well below the flammable range.

This kind of monitoring is a good idea, even if the excavation is less than 4 feet deep.

## **Getting In and Out**

[29 CFR 1926.651]

## **Falling Loads**

[29 CFR 1926.651]

## **Warning System for Vehicles**

[29 CFR 1926.651]

## **Hazardous Atmospheres**

[29 CFR 1926.651]

## **Inspection by a Competent Person**

[29 CFR 1926.651]

A competent person must inspect the excavation, the adjacent areas, and protective systems for any possibility of cave-ins, failure of protective systems, hazardous atmospheres, or other hazardous conditions.

Additional inspections must take place during the shift.

Inspections must be made after any rainstorm or other event that might increase hazards at the excavation.

If there is a hazardous condition, it must be corrected before workers are allowed in the excavation.

---

## **Water Accumulation**

[29 CFR 1926.651]

Employees must not work where water is accumulating, unless precautions are taken. These precautions depend on the situation, but could include special shield systems to prevent cave-ins, water pumps, or safety harnesses and lifelines. If pumps are used, a competent person must monitor their operation.

If there is a stream, then the contractor must construct a ditch or a dike to prevent the excavation from flooding.

---

## **Adjacent Structures**

[29 CFR 1926.651]

Adjacent structures must be supported to prevent a cave in. A registered professional engineer must determine that the structure is adequately supported either by existing rock or a foundation under the structure, or by supports added in preparing for the excavation.



The OSHA Standard does not specifically require guardrails around an excavation, since these might interfere with the work. However, it's a good idea if they can be used.

The standard does require guardrails on a walkway that workers use to cross over a trench or other excavation if the walkway is six or more feet above the bottom of the trench or excavation.

If workers are on a scaffold in an excavation, then they need fall protection as required in the Fall Protection Standard and the Scaffolding Standard.

---

Emergency rescue equipment, such as breathing apparatus, a safety harness and line, or a basket stretcher, must be available nearby if there is a possibility of toxic materials getting into the excavation.

## **Fall Protection**

[29 CFR 1926.651]

## **Emergency Rescue Equipment**

[29 CFR 1926.651]

## Soil Is Heavy

Soil is heavy. One cubic foot weighs more than 100 pounds. If you go one foot down, there is a downward pressure of 100 pounds per square foot (psi). At a depth of two feet it's 200 psi. Five feet down it's 500 psi. There is also pressure pushing outwards. This lateral pressure is about half of the downward pressure.

Think of the ground as made up of a lot of columns stacked next to each other. The sideways pressure from each column is supported by the pressure from the columns around it. They are all supporting each other.

When we cut an excavation, we take away the support from one side. The pressure pushes out with nothing to support it. Unless the soil is very cohesive (sticks to itself), it will give way.

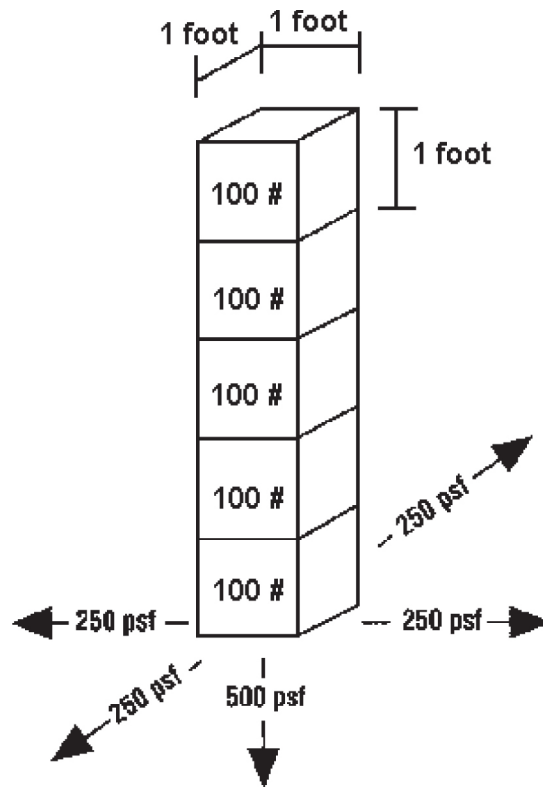

**Tension cracks** usually form at a distance of about  $\frac{1}{2}$  to  $\frac{3}{4}$  the depth of the trench away from the opening.



## Tension Cracks

**Sliding or sluffing** may occur as a result of tension cracks.

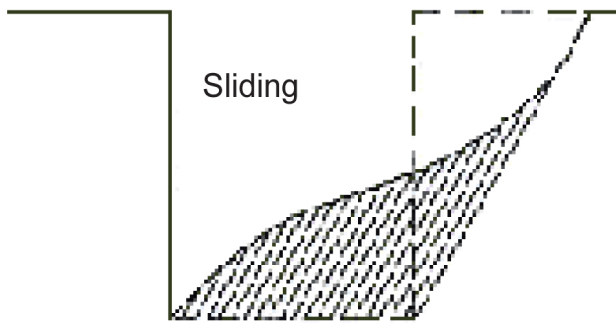

## Sliding or Sluffing

Tension cracks can also cause **toppling**.

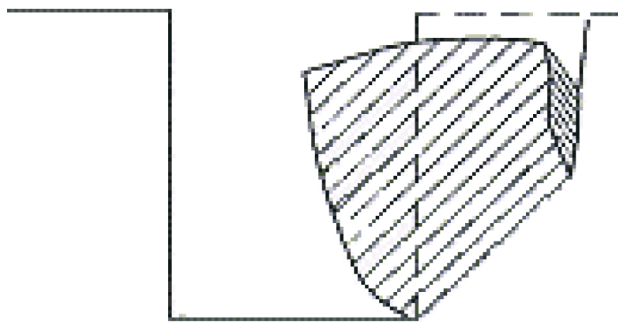

## Toppling

## **Subsidence and Bulging**

An unsupported excavation can cause subsidence or bulging at the surface and bulging of the vertical face of the trench. The trench may collapse.

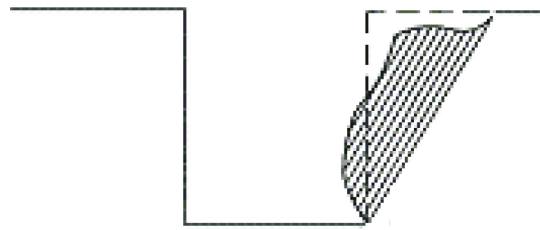

## **Heaving and Squeezing**

Bottom heaving or squeezing is caused by the downward pressure created by the weight of adjoining soil. This pressure causes a bulge in the bottom of the cut. Heaving and squeezing can occur even when shoring or shielding has been properly installed.

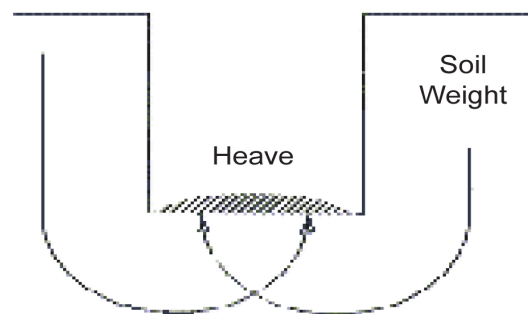

## **Boiling**

Boiling is an upward water flow into the bottom of the cut. A high water table is one of the causes of boiling. Boiling produces a "quick" condition in the bottom of the cut, and can occur even when shoring or trench boxes are used.

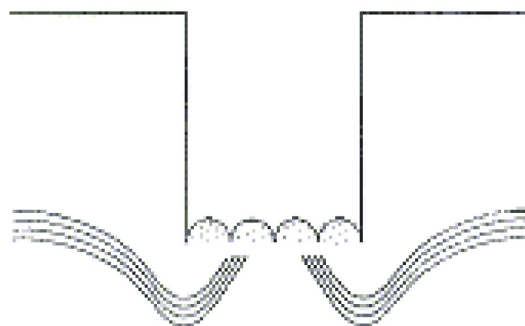

A competent person must determine what type of soil the excavation is in.

Some soils are more stable than others. At one extreme is rock, which might be so stable that it requires no shoring or other protective system. At the other extreme is sand, which is very unstable.

OSHA divides soils into four types:

- **Stable Rock.** Natural solid mineral matter that can be excavated with vertical sides and remain intact while exposed. It usually has a rock name such as granite or sandstone.
- **Type A Soil.** Very cohesive soils. “Cohesive” means that the soil particles stick to each other so that the soil is less likely to crumble apart. Examples of Type A soils include clay, silty clay, sandy clay, and clay loam.
- **Type B Soil.** Soils which are fairly cohesive, but less so than Type A. Examples of Type B soils include angular gravel, silt, silty loam, previously disturbed soils unless otherwise classified as Type C.
- **Type C Soil.** The least cohesive soils. Examples of Type C soils include granular gravel, sand, loamy sand, submerged soil, soil from which water is freely seeping, and submerged rock that is not stable.

But if a soil has cracks, has been disturbed (dug or moved before), is in a slanting layer, has seeping water, or is subject to vibration, then it is considered to be in a less cohesive type. For example, clay that has been disturbed is Type B, not A.

If there are layers of different soil types, then use the soil classification of the weakest layer.

## Testing the Soil

**Pocket Penetrometer.** This instrument measures how cohesive the soil is. Push it into the soil and the indicator displays the reading.

**Shearvane or Torvane.** This instrument has blades which you press into the soil. Then you turn the knob slowly and read the indicator when the soil breaks apart.

**Thumb Penetration Test.** Press your thumb firmly into the soil. If it's very difficult to make an indentation, the soil is probably Type A. If your thumb penetrates no further than the length of the thumb nail, it is probably Type B soil. If it penetrates the full length of the thumb, it is Type C soil. This is the least accurate test method.

**Dry Strength Test.** With experience one might be able to recognize different soil types by how easily the soil crumbles in your hand, how big the pieces are and whether the pieces break into smaller pieces. This test also is not very accurate.

**Plasticity or Wet Thread Test.** Moisten some soil and mold it into a ball. Roll it into a 1/8 inch thread. Break off 2 inches. Hold by one end. If it doesn't break, it's probably Type A or Type B.

**Visual Inspection.** Look at the soil being excavated. If it remains in clumps, it is cohesive; if it looks like sand or gravel, it's not very cohesive. Check for cracks and fissures developing near the excavation. Look at the open sides of the excavation to see if there are layers of different types of soil. Look for signs of bulging, or sliding. Look for water running in from the surface or seeping in underground.

The OSHA Excavation Standard describes two types of protective systems to prevent cave ins:

- Benching and sloping systems.
- Support systems (shoring and shielding).

An excavation must have one or the other (or a combination) of these protective systems.



Sloping

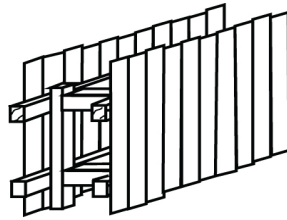

Shoring

**Exceptions.** A protective system is not required if:

- The entire excavation is in stable rock, or
- The excavation is less than five feet deep and a competent person has examined the ground and determined that there is no indication of a potential cave-in.

Many workers have died in trenching accidents because adequate shoring was not in place. Every trench that is 5 feet or more deep must have shoring or shields — or have benching or sloping. Otherwise, no one may enter.

State standards. Some states have stricter standards. Your state might require protective systems if the trench is four feet deep.

# Sloping

Sloping protects workers in a trench or other excavation. The sides are cut at an angle so that they won't collapse.

The angle has to be more gradual if the soil is less cohesive. In other words, for Type B it's less steep than for Type A. For Type C it's even more gradual.

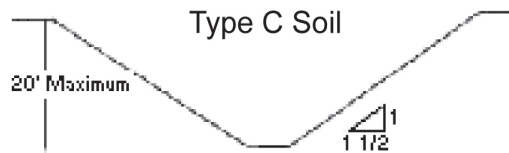
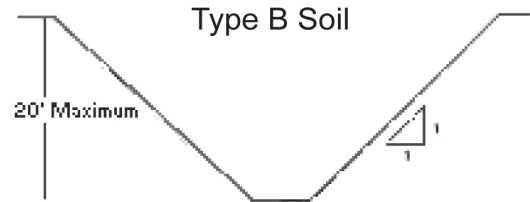
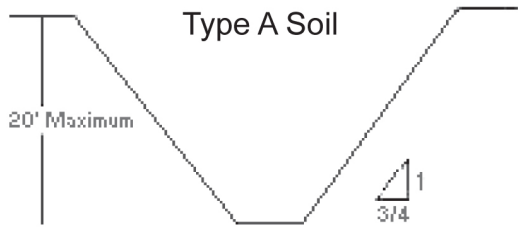

# Benching

In Type A or Type B soil it is possible to cut steps to prevent collapse. This is called **benching**.

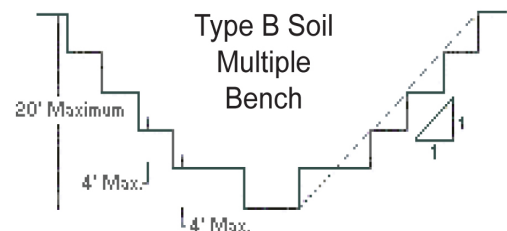
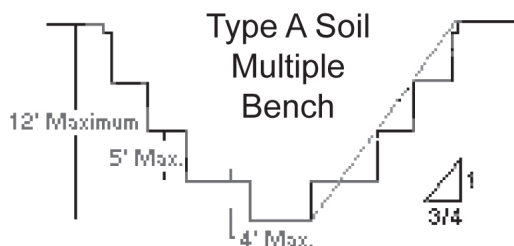
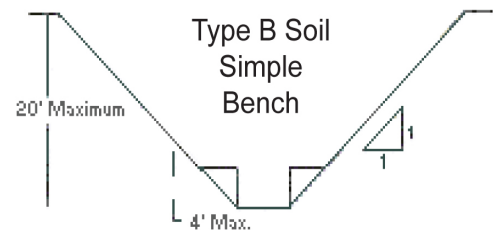
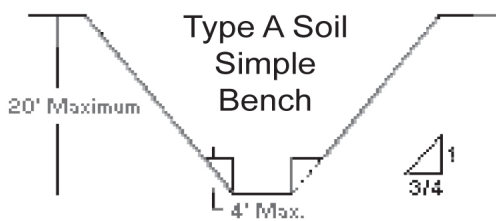



## Shoring

There are two types of shoring: timber shoring and mechanical jack shoring.

A competent person must supervise the installation and removal, and inspect the shoring before each work shift.

Install all shoring from the top down. Remove shoring from the bottom up.

Timber shoring is a system of wooden posts, wales, struts, and sheeting. Workers have to enter the trench in order to install or remove it - during this time they are not completely protected.

## Timber Shoring

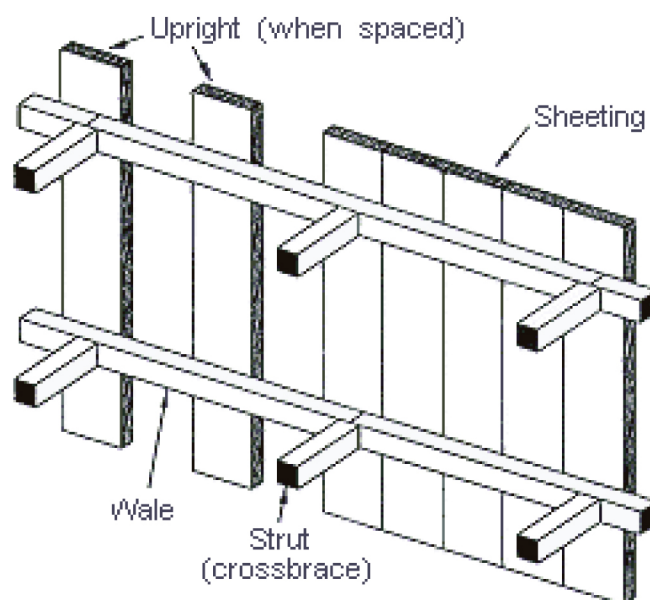

## Mechanical Jack Shoring

**Mechanical jack shoring** uses hydraulic, pneumatic or screw jacks as cross braces or struts. There are systems where the wales and sheeting are made of aluminum or steel and are designed to fit the jacks.

Some types of hydraulic and pneumatic shoring can be installed and removed without a worker having to enter the trench. Some aluminum systems are so light that a single person can install it.

Hydraulic and pneumatic shoring should be checked at least once per shift by a **competent person** for leaking hoses or cylinders, broken connections, cracked nipples, bent bases, and any other damaged or defective parts.

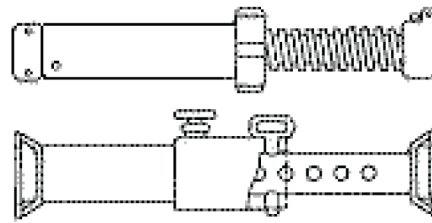

pneumatic/hydraulic jacks

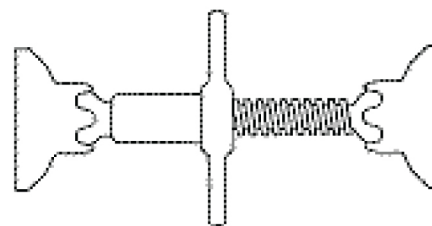

screw jacks

## Shielding and Trench Boxes

Shields or trench boxes are different from shoring. They are not designed to support the sides of the excavation. Rather they are intended to protect workers inside of the shield if the excavation caves in.

Shields are designed to safely handle certain loads. Do not use a shield or trench box in a situation that it was not designed for. Again, a competent person must assure that the shield or trench box is used properly.

The excavated area between the outside of the trench box and the face of the trench should be as small as possible. This space is usually backfilled to prevent the box from moving.

Trench boxes may be used in combination with sloping and benching. The box should extend at least 18 inches above the surrounding area if there is a sloping toward excavation. This can be accomplished by providing a benched area adjacent to the box.

Earth excavation to a depth of 2 feet below the shield is permitted, but only if the shield is designed to resist the forces calculated for the full depth of the trench and there are no indications that soil is slipping from behind or below the box's supports.

A competent person must regularly inspect the trench box for signs of bulging, heaving, boiling and vibration.

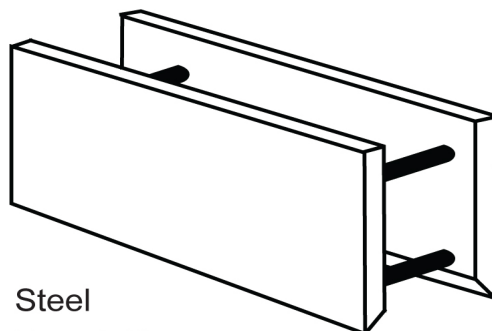

Steel  
Trench Box

Module

13

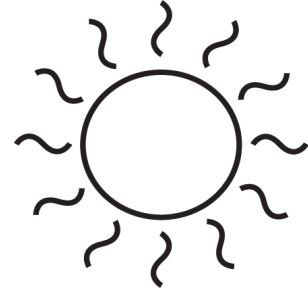

## Heat, Noise & Ergonomic Hazards

### Learning objectives

This module reviews the hazards of heat stress, noise exposure and heavy lifting at construction sites, and describes safe work practices and control measures to reduce injury and illness caused by these hazards.

After completing this module you will be able to demonstrate your ability to:

1. IDENTIFY the four types of heat stress.
2. IDENTIFY the conditions that cause heat stress.
3. IDENTIFY ways to prevent heat stress.
4. IDENTIFY the hazard caused by exposure to loud noise.
5. IDENTIFY the symptom caused by improper lifting.
6. DESCRIBE the correct technique for lifting.

Heat stress can be a serious, life-threatening hazard, especially for workers wearing impermeable protective clothing. Heat stress means that your body is having trouble keeping its temperature at the normal level – about 99°F. It means that your body is overheating.

Heat in your body comes from two sources:

- Heat muscles make as they work.
- Heat from the environment around you.

If your body gets too hot it means that:

- You are working too hard, and/or
- The environment is too hot, and/or
- Something is keeping your body's cooling system from working effectively.

Your body has a cooling system. As the body gets hotter, it sends more blood to the skin where heat in the blood dissipates into the air. This is like the way hot water from an engine goes to the radiator where it gives off heat. Your body also sweats. As the sweat evaporates, it takes even more heat with it.

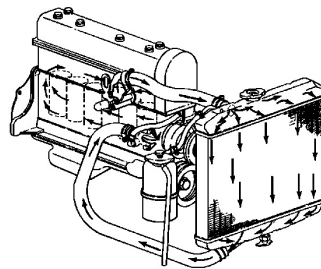
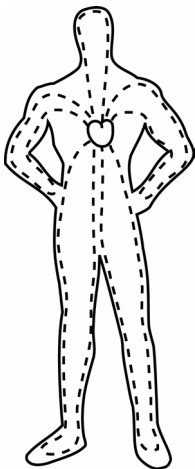

## Heat Stress

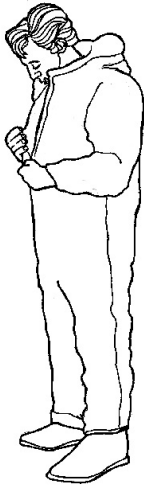

---

Protective clothing can cause heat stress even if it's not very hot out.

---

Heat stress is possible if you are working in a hot environment.

Heat stress is also possible if you are wearing protective clothing – even when it isn't very hot.

Protective clothing can keep chemicals out. But these garments also trap sweat inside, and keep it from evaporating. Sweating only cools if the sweat evaporates. **If sweat can't evaporate, it can't cool.**

If you wear heavier or more protective clothing than you need, you may create a new hazard: heat stress.

Even in moderate weather, it's possible to suffer heat stress if you're in protective clothing that interferes with your body's cooling.

It's important to recognize the signs and symptoms of heat stress so you can take preventive action before heat stress causes serious problems. Preventive action means adequate rest breaks, drinking plenty of water, and not working harder than your fitness allows.

There are four types of adverse health effects caused by heat stress:

**Heat Rash.** Itchy rash that occurs when the skin becomes swollen and plugs the sweat glands. This is not a life-threatening condition, but indicates that heat stress conditions may be present.

**Heat Cramps.** These are painful cramps caused when sweating diminishes water and electrolytes so that not enough are available for your working muscles. This is not life threatening, but it indicates you are working under heat stress conditions. Stop work; rest in a cool, shaded area; and drink fluids.

**Heat Exhaustion.** You feel worn-out, nauseous, dizzy or faint. Heavy sweating. You may have rapid, shallow breathing. Stop work: rest in a cool place. Drink fluids. Get medical assistance: heat exhaustion can develop into deadly heat stroke.

**Heat Stroke.** This is a serious medical emergency. Call emergency medical help now! Symptoms include:

- Hot, red, dry skin with little or no sweating.
- Very rapid pulse.
- Temperature above 105°F.
- Dizziness, nausea, delirium or possible coma.

One half of all heat stroke victims die. Get help immediately!

## Reactions to Heat Stress

---

### Heat Stress Can Kill

Heat stress is one of the most serious hazards you might encounter on a construction site. There are many possible effects of heat stress. The most dangerous effect is called heat stroke. Heat stroke is a serious medical condition. Almost one half of all people who experience heat stroke die as a result.

---

## Monitoring for Heat Stress

You should monitor yourself for heat stress whenever you work in a hot environment. You should also monitor yourself whenever you wear impermeable protective clothing, even if it's not hot out. Here's how:

- **Check your pulse.** Take your pulse when you begin a break. If your heart rate is more than 110 beats per minute, then you should shorten your next work period, or work less vigorously. Touch your arm lightly just above the wrist. Count the beats for 15 seconds. Multiply by 4 to get beats per minute.
- **Take Your Temperature.** Take your temperature at the beginning of a break, before drinking. Keep the thermometer under your tongue for at least two minutes. Normal body temperature is about 99 °F. If your temperature is above 100 °F, shorten your next work period, or work less vigorously.
- **Weigh Yourself.** Weigh yourself at the beginning and end of the day. If you've lost more than a pound in one day, this is probably water loss. You need to drink more.

## Becoming Acclimated

---

If you are healthy and are not wearing protective clothing that interferes with sweat evaporation, then you may become used to the heat. This takes several days, so take it easy at first. If you are wearing protective clothing, your sweat may not be able to evaporate. It's possible to suffer heat stress no matter how fit you are, no matter how "used to it" you are.



There are several ways to help prevent heat stress:

- **Recognize the signs of heat stress in yourself and in your fellow workers.** Often we don't notice what's happening to ourselves. If your buddy looks like they're having a hard time, getting too red, sweating too much, or acting dizzy and uncoordinated, don't be afraid to say something. You might be saving their life.
- **Adjust Schedules.** Take breaks. Heavy work in protective clothing or in a hot environment may require more time resting than working. Schedule heavy work in the coolest part of the day, or at night.
- **Provide Rest Shelters.** Have shaded rest shelters with chairs or benches. Air conditioning is even better.
- **Drink fluids.** Sweating cools the body, but it also robs the body of fluid. Drink enough to replace what you lose. You may not feel thirsty until you've become dehydrated. Drink regularly throughout the day. Don't wait until you're thirsty. Your employer is required to provide clean running water, or sanitary, insulated water jugs.
- **Keep Fit.** The healthier you are, the more resistant your body is to conditions that cause heat stress. Your muscles work more efficiently and your body is better able to transfer heat to your skin surface where sweating can dissipate this heat.

## Preventing Heat Stress

---

You don't feel thirsty until you've started to dehydrate. Drink water or other fluids regularly throughout the day, before you get thirsty.

---

## Noise Exposure

---

Industrial hearing loss is a permanent condition. There is no cure. That's why prevention is so important.

---

Long term (chronic) exposure to loud noise levels at work can harm your hearing by damaging or destroying nerve cells in your inner ear. This kind of hearing damage is called industrial hearing loss.

**This is a permanent condition.** Because it develops slowly, over several years of noise exposure, you won't notice it until it's too late, until one day when you realize that you can't understand your grandchildren, or that music just doesn't sound right anymore.

You need to protect yourself now in order to prevent hearing loss later.

---

## Controlling Noise Exposure

OSHA has two different standards for noise exposures. One is for workers in general industry [29 CFR 1910.95].

The other standard is for workers in the construction industry. [29 CFR 1926.52]

Both standards require the employer to control noise exposure with engineering controls (which includes good maintenance) and administrative controls (like limiting the amount of time a worker is exposed).

If, despite using engineering and administrative controls, your average daily exposure is 90 dBA or above, OSHA requires hearing protection (plugs or muffs) to be worn.



## Hearing Conservation Programs

The General Industry Standard also requires a hearing conservation program if average sound levels are 85 dBA or above. The program must include:

- Training and information about risks and how to control them;
- Measuring noise levels at work;
- Annual hearing exams;
- Engineering and administrative controls, where feasible;
- Protective equipment; and
- Keeping records.

Even if your work site is “construction industry,” it’s still a good idea to have a hearing conservation program, including training and annual exams.

---

Noise is measured with a sound level meter which reads in decibels. We use the abbreviation “dBA” for decibels. The “A” means that OSHA requires a certain type of sound level meter, an “A scale” meter. A conversation in a quiet room makes about 60 dBA. A jet engine can create 150 dBA.

Decibels are different than ordinary numbers. According to OSHA, every time the sound level goes up 5 dBA, it’s twice as loud! So, 95 dBA is twice as loud as 90 dBA. 100 dBA is four times as loud as 90 dBA.

If your average daily exposure is 90 dBA or above, OSHA requires hearing protection (plugs or muffs).

[29 CFR 1910.95(b)(1) and 29 CFR 1926.52(b)]

## Measuring Noise

## Noise Limits

The sound level you experience from a piece of equipment depends on what it is, how well it is maintained, whether it has sound insulation, how close you are, and whether you wear hearing protection.

How the sound level affects you depends on how loud it is and on how long you are exposed. OSHA says that an average of 90 dBA for eight hours is the most you are supposed to receive. This is the same as just four hours at 95 dBA, 2 hours at 100 dBA, 1 hour at 105 dBA, ½ hour at 110 dBA or ¼ hour at 115 dBA.

### OSHA PEL for NOISE

90 dBA	8 hours
95 dBA	4 hours
100 dBA	2 hours
105 dBA	1 hour
110 dBA	30 minutes
115 dBA	15 minutes
Above 115 dBA	Not allowed

### Typical Sound Levels

170 dBA	Space shuttle takeoff
160 dBA	
150 dBA	Jet engine
140 dBA	Threshold of pain
130 dBA	
120 dBA	Pneumatic chipper
110 dBA	Bulldozer
100 dBA	Diesel truck passing by
90 dBA	Plugs or muffs required
80 dBA	Noisy office
70 dBA	Vacuum cleaner
60 dBA	Conversation
50 dBA	Quiet office
40 dBA	Quiet home
30 dBA	Recording studio
20 dBA	Whisper
10 dBA	Quietest sound a healthy ear can hear

### What's the difference between noise and sound?

It's like the difference between a weed and a flower. Noise is sound that's not wanted. Whether you call it sound or noise depends on your point of view. Whether it can harm your hearing depends on how loud it is and how long you are exposed. Many an aging rock star knows the hearing damage caused by exposure to loud sound.

Ergonomic hazards can cause injuries to muscles, tendons, ligaments, joints, cartilage, and nerves. These injuries most often involve the back, shoulders, neck, legs, arms, wrists and hands.

There are many different names used for ergonomic injuries:

- Musculoskeletal disorder (MSD).
- Repetitive stress injury.
- Cumulative trauma disorders.
- Carpal tunnel syndrome.
- Lower back pain.
- Disk injury.
- Tendonitis.
- Sciatica.

These are painful and often disabling conditions that often develop over a long period of time. They are very difficult to cure, so prevention is always important.

MSDs can cause pain, numbness, tingling, stiff joints, difficulty moving, muscle loss, and paralysis. This can result in lost time or even the inability to work at all.

You might have a musculoskeletal disorder if you have any of these symptoms:

- Numbness in your fingers.
- Numbness in your thighs.
- Stiff joints.
- Back pain.

## Ergonomic Hazards



Correct



Wrong!

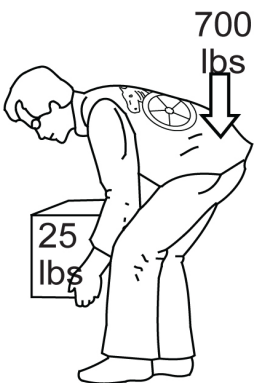

Lifting is one of the most common ergonomic hazards. Improper lifting can cause serious back injury.

Construction workers and hazardous waste workers move materials. They put drums in overpacks, move materials and equipment, load and unload trucks. These activities often require lifting heavy objects by hand. If not done correctly, lifting can injure your back.

**Proper Lifting Technique.** To prevent painful, possibly permanent injury, use the proper technique.

- Don't overestimate your strength: if it's too bulky or too heavy, get assistance.
- Keep the back straight and lift with the legs.
- Lift slowly and carefully.
- Keep the load as close to your body as possible.
- Don't turn or twist while you are lifting.
- Be just as careful putting the load down.

Lifting puts a tremendous strain on the muscles and discs in the lower back. Even a worker using proper technique has a force of several hundred pounds on the lower back.

If the load is too heavy, or if the worker reaches out too far, or twists while lifting, the force can be many times greater, even if the weight of the object is not very great.

The job should be planned to minimize the amount of manual lifting. There should be enough workers to lift safely. Use drum grapplers, fork trucks and boom trucks whenever possible.

## Ergonomic Hazards

Ergonomics means designing jobs to fit the worker, rather than forcing the worker's body to fit the job.

Ergonomics means adapting job tasks, work stations, tools, vehicles and equipment to fit the worker in order to reduce physical stress on the worker's body and to eliminate potentially serious, disabling injuries like musculoskeletal disorders (MSD).

Examples of ergonomic solutions include fully adjustable driver's seats, preventive maintenance to reduce vibration, and good job planning to minimize manual lifting.

Back belts. Do back supports work? NIOSH studied workers who do lifting. They found that workers wearing supports are just as likely to be injured as those who don't use them.

Makers of back supports, and also some scientists and workers, disagree with NIOSH. Many people believe supports help because they remind you to use proper technique. One thing is certain: a back support won't make you stronger. Don't assume that you can lift more just because you have one.

Module

14



## Fire Prevention Plans and Fire Protection

### Learning objectives

This module reviews the fire prevention plans and fire protection equipment required at construction sites.

After completing this module you will be able to demonstrate your ability to:

1. DEFINE **Flammable** and **Combustible**.
2. IDENTIFY the four classes of fire extinguishers and the class of fire each is used for.
3. IDENTIFY the purpose of bonding and grounding containers of flammable materials.
4. IDENTIFY five general fire safety requirements for construction sites.

**Fire Protection and Prevention** is **Subpart F** of the OSHA Construction Standards. This standard has ten sections as shown in the box on the following page.



## **Fire Hazards at Construction Sites**

Fire is a danger at construction sites. Many building materials, such as wood, are combustible. Also, there are many flammable and combustible materials in use, including gasoline, diesel fuel, cleaning solvents, and paints. Kerosene and liquefied petroleum gas are often used for temporary heating. Waste materials can also accumulate on the site and create a fire hazard.

Construction work often includes activities, such as welding and cutting, that can ignite flammable and combustible materials. Electrical equipment, power tools, and vehicle exhaust can also be sources of ignition.

Employers must have a practical, comprehensive fire protection and prevention plan that include the necessary equipment and safe work practices to prevent, as far as possible, the risk of fire. The plan must also include how workers and management will respond in the event a fire does break out.

### **Fire Protection and Prevention 29 CFR 1926, Subpart F**

Fire Protection 29 CFR 1926.150

Definitions 29 CFR 1926.155

Fire Prevention 29 CFR 1926.151

Fixed Extinguishing Systems, General 29 CFR 1910.160

Flammable and Combustible Liquids 29 CFR 1926.152

Fixed Extinguishing Systems, Gaseous Agent 29 CFR 1910.162

Liquefied Petroleum Gas 29 CFR 1926.153

Fire Detection Systems 29 CFR 1910.164

Temporary Heating Devices 29 CFR 1926.154

Employer Alarm Systems 29 CFR 1910.165

## Fire Protection

[29 CFR 1926.150]

**Fire Protection Program:** The employer shall have a comprehensive Fire Protection Program in place throughout all phases of the construction project.

**Fire Extinguishers:** There must be adequate fire extinguishers of the right kind for the classes of fire that might occur.

**Fixed Fire Fighting Systems:** If the facility that is being constructed includes an automatic sprinkler system, then the installation of the sprinkler system shall closely follow the building construction. The sprinkler system shall be placed in service as each floor is completed (subject to applicable local inspection and permitting).

**Fire Alarms:** An alarm system, which may be a telephone, must be provided to allow employees to alert the local fire department in case of emergency.

**Fire Cutoffs:** If the project includes fire doors with automatic closing devices, emergency stairs or fire walls, these shall be installed as soon as practicable.

**Ignition Hazards:** All wiring and electrical equipment shall be installed in accordance with the Electrical Standard (Subpart K).

**Internal Combustion Engines:** Locate equipment powered by internal combustion engines so that the exhaust is not directed toward combustible materials.

**No Smoking:** Smoking shall be prohibited around any operation, equipment or material that poses a fire hazard. Post “NO SMOKING” or “NO OPEN FLAME” signs.

**Housekeeping:** The entire site shall be kept free from the accumulation of unnecessary combustible materials.

**Storage:** Storage shall not obstruct the path of travel to emergency exits.

## **Fire Prevention**

[29 CFR 1926.151]

# Fire and Explosion



---

Combustion: the chemical reaction between fuel and oxygen which gives off heat and light.

---

---

To put out a fire, remove at least one component of the fire pyramid.

---

A material that can act as a fuel (that can burn) is called a combustible or a flammable material. Later we will explain the difference between these two terms. A material that doesn't burn is called non-combustible.

Four things are necessary for fire:

1. Fuel.
2. Oxygen.
3. Ignition source (heat) to start the process.
4. Chain reaction to keep the fire going.

We call this the fire pyramid. If any component is missing, the fire can't happen. If a fire starts, we have to remove at least one component in order to put it out.

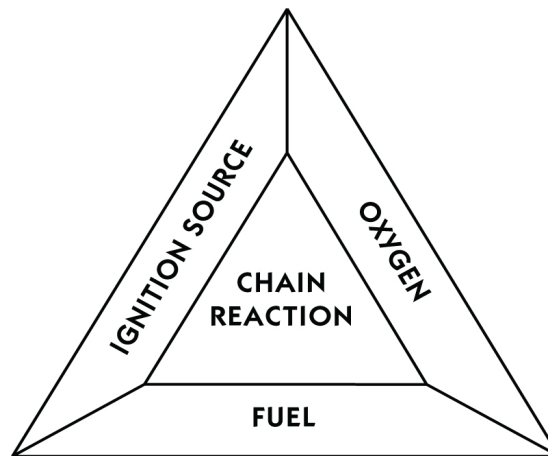

To have an explosion of flammable vapors in the air, there has to be the right mixture of vapor (fuel) and oxygen. If there is too little vapor, it won't burn. If there is too much vapor, it won't burn either.

The Lower Explosive Limit (LEL) is the smallest concentration of vapor in the air that will sustain a chain reaction and burn in the air, creating a vapor explosion.

The LEL is different for different chemicals. For gasoline it's 1.4%. At least 1.4% of the molecules in the air have to be gasoline in order to start a fire or explosion.

If there's a release of flammable vapor into the air, we want to be certain that the concentration is far below the LEL. This is because conditions could change. More fuel could evaporate, or the concentration could be greater as we move deeper into a confined space or closer to the source of the fuel. Also, the instrument we use to measure the concentration might not be accurate.

OSHA requires the concentration to be less than 10% of the LEL. [29 CFR 1910.146(b)]

A prudent safety and health program might establish an even lower action level (the point at which you have to leave the area). We can use ventilation to lower the concentration below the action level.

## Flammable Vapor Explosions

---

OSHA requires the concentration to be less than 10% of the LEL in order for workers to remain in the area.

---

## Flash Point

---

The Flash Point is the lowest temperature of a liquid at which it gives off enough vapor so that a spark will set off a fire or explosion.

---

---

Low flash point means high hazard.

---

Liquids evaporate more easily as they get warmer, and they evaporate less if they are colder.

The flash point is the lowest temperature of a liquid at which it gives off enough vapor so that a spark will set off a fire or explosion.

A low flash point tells you a material is dangerous. Consider gasoline. It's flash point is minus 45°F. Anytime gasoline is warmer than minus 45°, there will be enough vapor to have a fire or explosion. This means that in any situation (except maybe at the South Pole) liquid gasoline creates enough vapor to burn.

Consider diesel fuel. It's flash point is around 130°. Diesel fuel is not as easy to start burning as gasoline.

A **flammable liquid** is one that has a low flash point so that under normal conditions there's enough vapor that a spark will set off a fire or explosion.

A **combustible liquid** is one that has a flash point higher than the temperatures we consider normal. This means that under normal conditions there won't be enough vapor for a spark to set off a fire or explosion.

## Flash Point

What's normal temperature? The NFPA (National Fire Protection Association) says that if the flash point is below 100° F, the material is considered flammable. If the flash point is 100° or above, it's combustible. The idea is that most of the time the temperature doesn't get above 100°, so it isn't hot enough for the liquid to give off enough vapor to burn or explode.

The Department of Transportation (DOT) calls a liquid flammable if the flash point is 140° or less.

[49 CFR 173.120(a)]

DOT calls a liquid combustible if it has a flash point above 140°.[49 CFR 173.120(b)]

DOT recognizes that sometimes liquids do get hotter than 100°. This could happen in a tanker on a sunny day, in drums in a sealed trailer in the sun, or on a warm day in Tucson.

The idea behind both the NFPA and DOT systems is that we need to be more careful with flammable liquids because even a little spark could cause a fire.

---

A DOT Flammable Liquid has a flash point of 140° or less.

A DOT Combustible Liquid has a flash point of 141° or more.

---

## Bonding and Grounding

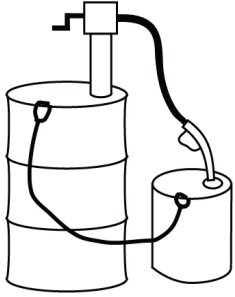

---

**Bonding:** connecting a good conductor between two containers to prevent a spark.

---

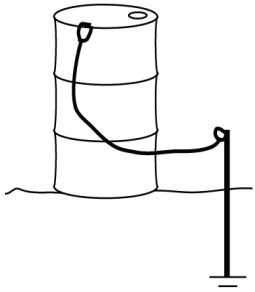

---

**Grounding:** connecting a good conductor between a container and the earth to prevent a spark.

---

Because a tiny spark can ignite the vapors, it is essential to prevent all sparks when handling flammable liquids.

Static electricity is produced when dissimilar materials rub together. Friction transfers electrons from one object to the other. If the extra electrons have no way to leave, they just sit there. That's what "static" means.

A spark occurs when the object with the extra electrons gets close to another object that can conduct electricity. The electrons jump through the air to the conductor. When you walk across a nylon carpet wearing rubber soles, electrons transfer from the carpet to your body. When you are about to touch a door knob, the electrons jump to the knob.

When liquid flows through a hose, or pours out of a container, friction causes electrons to transfer from the liquid to the container. When the spout touches another container, there could be a spark which ignites the vapors coming from the liquid.

**Bonding** is connecting a good conductor (such as a copper wire) between two containers so that any extra electrons on one container can flow easily to the other container without causing a spark.

**Grounding** is connecting a good conductor (such as a copper wire) between a container and the earth. This prevents a spark from jumping between the container and a metal object that is in contact with the earth.

Not just any old wire will do. Use heavy gauge copper wire with special connectors that are designed for this purpose. These connectors are either clamps with sharp pointed screws, or special heavy duty clips. The connector has to make a good contact with the container, piercing through the rust or paint.



There are many different flammable and combustible liquids on construction sites: fuels, lubricants, paints, solvents, etc. There are also combustible solids such as wood and paper. If a fire starts, the first line of defense is often the portable fire extinguisher.

There are different types of extinguishers for different types of fires. Using the wrong type of extinguisher could be ineffective, or even dangerous. For example, using water on an oil fire will spread the fire because the burning oil can float on top of the water. The heat could also cause the water to boil with explosive force, blowing burning oil in all directions. Also, using water on a fire around electrical equipment may cause electrical short circuits that damage equipment or cause an electrocution hazard.

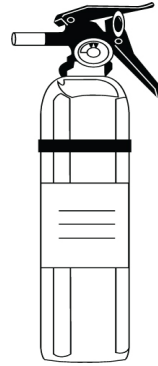

## Fire Extinguishers

---

If you might be expected to use a fire extinguisher, then you should have hands-on training on how to use it properly.

---

### The NFPA Classification of Fires and Fire Extinguishers

- A** For cellulose fuels like wood and paper. These extinguishers may contain water, multipurpose dry chemical or halon.
- B** For flammable or combustible liquids. These extinguishers may contain dry chemical, carbon dioxide or halon.
- C** For fires around electrical equipment. These use an agent that does not conduct electricity (carbon dioxide, dry chemicals or halon). These agents are effective against other types of fire, so a type C extinguisher also has an A or a B rating, or all three (ABC).
- D** Fires of combustible metals such as magnesium or sodium. Water and some common extinguishing agents react with these metals making the fire worse. The agent used depends on the metal for which the extinguisher was designed.

## Extinguishing Agents

Agent	Use On	How it Works	Advantages	Disadvantages
Water H <sub>2</sub> O	A	Removes HEAT from the fire pyramid. Makes the fire too cold to burn.	Very effective on class A fires. Inexpensive. Readily available. Non-toxic.	Conducts electricity. May spread class B fires. Freezes in cold climates.
Carbon Dioxide CO <sub>2</sub>	B-C	Removes OXYGEN from the fire pyramid.	Effective on class B and C fires. Does not conduct electricity. Does not react with most other chemicals.	Dissipates rapidly - smoldering materials may ignite again. 1½ times as heavy as air - can collect in low areas. Need more than 35% by volume in air in a total flooding system - more than 4% in air is toxic. Chilling effect may damage equipment
Dry Chemical (Sodium Bicarbonate)	B-C	Breaks the CHAIN REACTION in the fire pyramid.	Effective on class B and C fires. Does not conduct electricity. Generally considered to be non-toxic. (Sodium bicarbonate is the same thing as baking soda.)	Often not very effective on class A fires. Absorbs moisture and may harden in the container. Irritating to some people. Nozzle pressure may cause burning liquids to splash.

<b>Extinguishing Agents (Continued)</b>				
<b>Agent</b>	<b>Use On</b>	<b>How it Works</b>	<b>Advantages</b>	<b>Disadvantages</b>
Multi-purpose Dry Chemical (Aluminum phosphate)	<b>A-B-C</b>	Breaks the CHAIN REACTION in the fire pyramid.	Effective on class A, B and C fires. Does not conduct electricity.	Obscures vision. More irritating than regular dry chemical agent. Nozzle pressure can cause burning liquids to splash.
Halon 1211 (Bromochloro-difluoromethane)	<b>A-B-C</b>	Breaks the CHAIN REACTION in the fire pyramid.	Effective on class A, B and C fires. Does not conduct electricity.	Acutely toxic - 4% in air can cause heart arrhythmia and dizziness. Toxic decomposition products. Chilling may damage equipment. Depletes the ozone layer. Heavier than air.
Halon 1301 (Bromo tri-fluoromethane)	<b>A-B-C</b>	Breaks the CHAIN REACTION in the fire pyramid.	Effective on class A, B and C fires. Does not conduct electricity. Does not cause chilling.	Acutely toxic - 10% in air causes dizziness and heart arrhythmia. Toxic decomposition products. Depletes the ozone layer. Heavier than air.

## **Construction Site Fire Safety Checklist**

- Approved containers used for storing and handling of flammable and combustible liquids.
- All flammable liquids stored in closed containers.
- Rigid separators between stacked containers of combustibles or flammables - to assure support and stability.
- Fuel gas cylinders and oxygen cylinders separated by distance, and fire-resistant barriers, while in storage.
- Storage tanks adequately vented to prevent the development of excessive vacuum or pressure.
- Storage rooms for flammable and combustible liquids have explosion-proof lights.
- Storage rooms for flammable and combustible liquids have adequate ventilation.
- Bulk drums of flammable liquids grounded and bonded to containers during dispensing.
- Safety cans used for dispensing flammable or combustible liquids at a point of use.
- All spills of flammable or combustible liquids cleaned up promptly.
- All combustible waste such as oily rags must be stored in covered metal receptacles.

**Construction  
Site Fire Safety  
Checklist  
(Continued)**

- Proper fire extinguishers provided for the types of materials in areas where they are to be used.
- Proper fire extinguishers mounted within 75 feet of outside areas containing flammable liquids, and within 10 feet of inside storage areas.
- Extinguishers free from obstructions or blockage.
- All extinguishers serviced and tagged at intervals not to exceed 1 year.
- All extinguishers fully charged and in their designated places.
- If sprinkler systems are permanently installed, the nozzle heads are directed so that water will not spray into operating electrical equipment.
- LPG (propane) stored, handled, and used in accordance with safe practices and standards.
- LPG tanks guarded to prevent damage from vehicles.
- “NO SMOKING” signs posted on LPG tanks.
- “NO SMOKING” signs posted where flammable or combustible materials are used or stored.
- “NO SMOKING” rules enforced.

Module

15



## Confined Spaces

### Learning objectives

This module reviews awareness training about the hazards of confined spaces so that you will be able to recognize and avoid them.

If your job requires that you enter a confined space, then you must first receive more detailed training including site specific information about your employer's confined space entry and rescue procedures.

After completing this module you will be able to demonstrate your ability to:

1. IDENTIFY five characteristics that make a confined space hazardous.
2. IDENTIFY three hazardous atmospheres found in confined spaces.
3. IDENTIFY two reasons why a confined space permit is important.

Many confined spaces are easy to recognize: tanks, tank trucks, tank cars, boilers, pipelines, septic tanks, manholes, utility vaults, sewers and ventilation ducts.

In some cases, it might be less obvious that a work area is a confined space. For example, sumps and pits can be confined spaces even though they are open to the air.

Any type of health or safety hazard might be present in a confined space. However, if an accident or hazardous exposure occurs, the consequences are often worse because they occur in a confined space.

For example, using a chipping hammer to remove slag or corrosion is a noisy operation. Inside a steel tank the noise is even louder. When using a solvent to remove grease, toxic vapors may be released. In a sump pit the concentration of vapors will be greater because there is less air to dilute them. Also, if an accident occurs, it is more difficult to escape or to be rescued from a confined space.



## What Is A Confined Space?

---

Any health or safety hazard might exist in a confined space.

---

---

If anything bad occurs, it will be worse, because it's in a confined space.

---

## Confined Space Program

---

The OSHA Standard for confined spaces in general industry is:  
[29 CFR 1910.146]

---

OSHA requires a Confined Space Program that includes:

- Identifying and labelling confined spaces.
- A Confined Space Permit System.
- Evaluation of the hazards before anyone enters.
- Air monitoring before and during the entry.
- Specific safe work practices.
- All necessary safety equipment.
- Standby personnel to monitor workers inside and summon the rescue team if an accident occurs.
- Training for all workers and supervisors involved.
- Close-out procedures to make sure that all workers have left safely and it is OK to return the space to its intended purpose.
- A rescue plan.
- Procedures for sharing information about confined spaces if there are multiple contractors.



OSHA requires your employer to determine if there are any confined spaces in the workplace. Each confined space must be posted with a sign. This is an example:

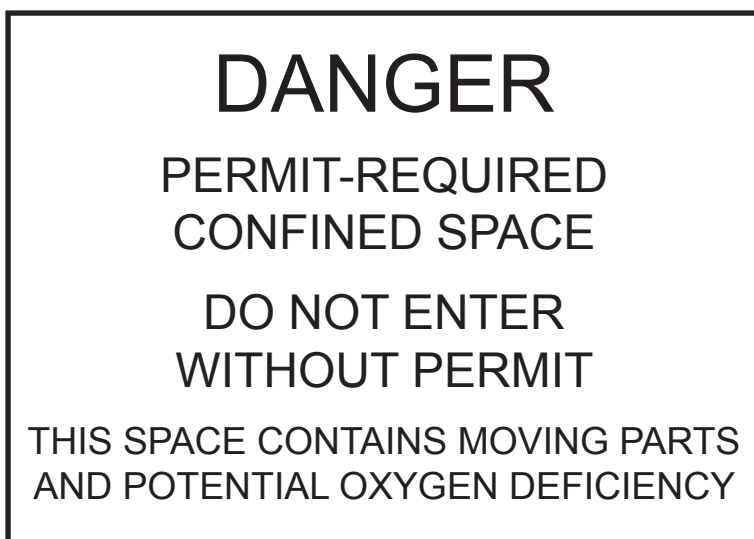

Although not specifically required by OSHA, a confined space sign might also include specific work practices such as what type of respirator to wear. The sign might also include an emergency phone number.

---

Entry means putting any part of your body into the confined space. If you stick your head through the opening to get a quick look or to sniff the air inside, you have just entered the confined space. These are unsafe work practices unless all safe entry procedures have been followed, including, if necessary, wearing the proper respirator.

## Labelling and Posting

---

In many cases it is appropriate to lock the confined space to prevent unauthorized entry.

---

## What Does “Entry” Mean?

---

Never stick your head inside to get a quick look or sniff the air. One breath could be fatal.

---

# What Makes Confined Spaces Dangerous ?

---

## Three types of air hazard:

1. Oxygen deficiency
  2. Flammables
  3. Toxic contaminants
- 

Several characteristics make confined spaces dangerous:

- **Restricted entry and exit** - It's hard to get in or out, and difficult for rescue personnel to respond quickly.
- **Not designed for continuous work** - The space was made for some other purpose, not for people to work there.
- **Poor ventilation** - It's hard for fresh air to get in or for contaminants to get out.
- **May contain a hazardous atmosphere**
  - Oxygen deficiency
  - Toxic air contaminants
  - Flammable
- **May contain other hazards**
  - Electrical hazards
  - Sparks
  - Moving machinery
  - Process liquids
  - Engulfment hazards
  - Extreme Temperatures
  - Noise
  - Falling objects

Never enter a confined space unless proper monitoring is being done. Stay out, or get out, if there is:

- **Less than 19½% oxygen** - Unless you are wearing an SCBA or an airline respirator with escape bottle.
- **More than 10% of the LEL of a flammable material.**
- **More than 50% of the PEL of an air contaminant.** - Unless you are wearing the proper respirator.
- **More than the IDLH of a toxic air contaminant** - Unless you are wearing an SCBA or an airline respirator with escape bottle.

Do not enter to do the initial testing. Use equipment with a hose or remote capability.

Continue monitoring while workers are inside. Conditions may change!

All monitoring must be done by a properly trained person using the appropriate, calibrated equipment.

## **Safety With Hazardous Atmospheres**

---

**To know it's safe, air monitoring must be done:**

1. Before anyone enters.
  2. During the time that workers are inside.
-

## Confined Space Permits

---

A Confined Space Permit takes time to fill out properly.

Don't cut corners. Failure to carefully complete the permit could cost lives.

---

---

If the work will be continued by a different crew, or by the same crew on a different shift, then a new permit should be issued.

---

The Confined Space Permit authorizes the work to be done and certifies that all necessary safety procedures are in place. The permit must include:

- The location of the confined space.
- The purpose of the entry.
- The date and duration of the entry.
- Names of all workers who will enter.
- Names of standby personnel.
- Supervisor's name and signature.
- Identification of all present or potential hazards.
- Specific procedures such as lock-out, ventilation and purging.
- Air testing to be done before and during entry.
- How to summon the Rescue Team.
- Communication procedures.
- List of all required PPE, including respirators.
- If "hot work" such as welding is to be done, an additional Hot Work Permit must be issued.

The permit is not just a piece of paper. It serves two very important purposes:

- Assures that time is taken to identify all hazards and to take all necessary precautions to protect the lives of workers. It's like the checklist that a pilot goes through before taking off.
- Requires the supervisor to take responsibility, in writing, for assuring that safe work practices are followed. It holds the supervisor accountable.

---

If monitoring reveals oxygen deficiency, toxic contaminants, or flammables then the space must be ventilated and tested again before workers enter.

Ventilation works best if clean air flows into the space at one end and exits at the other end. If the space has only one opening, blow or suck air through a hose located as far into the space as possible. Fresh air will travel through the space on its way out.

Use clean air. Make certain the blower's intake is not near a source of contaminants such as vehicle exhaust.

## **Why Is The Permit So Important?**

## **Ventilation and Purging**

## Lock-Out Tag-Out

---

Each worker should have their own lock. Equipment can only be turned on after each worker has removed their own lock.

---

## Standby Attendant

---

More than 50% of all the workers who die in confined space accidents are would-be rescuers who enter without the proper equipment and training.

---

It is essential to isolate a confined space from sources of hazardous energy. The best method is lock-out:

- Lock-out electrical circuits by removing circuit breakers and putting locks on the switches.
- Lock-out pipes by removing a section of pipe and sealing both exposed ends with solid plates. This is called “double blank and block.”
- Lock-out mechanical equipment by removing gears, drive shafts or chain drives.

Also tag-out the equipment with a sign to alert others that the equipment must remain out of service. Remember that tag-out by itself – without lock-out – does not prevent an accidental start-up.

---

A trained attendant (standby person) must be assigned to remain outside the confined space while workers are inside. The attendant should not have any other duties that prevent giving his or her full attention to the workers inside the confined space.

The attendant is responsible for starting the rescue procedure as described in the employer’s Safety and Health Plan. Usually this means calling the rescue team.

The attendant should only enter the confined space if he or she is part of the rescue team and is properly trained and equipped.

## Rescue

More than one half of all the workers who die in confined space accidents are would-be rescuers.

They die because they do not have the training or equipment to perform a safe rescue. It is normal to want to help your fellow worker. However, you are not helping if you only add to the list of fatalities.

The only effective way to protect confined space workers is to have a Rescue Plan and specially trained and equipped rescue personnel.

In many cases it is best to provide for non-entry rescue. This means that the workers entering the confined space are equipped with harnesses which will allow them to be extracted without anyone else actually entering.

OSHA allows the employer to rely on an off-site rescue team such as a fire department. However, these rescuers might arrive too late.

---

Many confined space accidents result in multiple deaths when would-be rescuers enter without the right training and equipment.

---

---

You have the best protection if your employer maintains a properly trained and equipped on-site rescue team.

---

Module

16



## Motor Vehicles

### Learning objectives

This module reviews the safety precautions that you need to follow when working with or around vehicles and heavy equipment.

After completing this module you will be able to demonstrate your ability to:

1. IDENTIFY when Rollover Protective Structures (ROPS) are required.
2. IDENTIFY when a back-up alarm is required.
3. IDENTIFY the safety precautions required when working on split rim tires.
4. IDENTIFY the safety requirements for working under raised equipment.
5. IDENTIFY three types of braking systems required on construction vehicles.



Motor Vehicles, Mechanized Equipment and Marine Operations is Subpart O of the OSHA Construction Standard. It has seven sections as shown in the box below.

In this module we will discuss the requirements of sections 600, 601, 602 and 604 with respect to motor vehicles and mechanized equipment that are used at construction sites on land.

**Powered Industrial Trucks:** This module includes a brief discussion of the safe operation of powered industrial trucks (forklifts, etc.). OSHA recently adopted a new standard which requires special training for workers who operate powered industrial trucks. The new standard is 29 CFR 1910.178(I). This module by itself does not fulfill the new OSHA training requirements. In order to meet the new requirements, operators must have hands-on training on the specific types of industrial trucks they will operate.

## Overview of the OSHA Standard

### **Motor Vehicles, Mechanized Equipment and Marine Operations 29 CFR 1926, Subpart O**

Equipment .....	29 CFR 1926.600
Motor Vehicles .....	29 CFR 1926.601
Material Handling Equipment .....	29 CFR 1926.602
Pile Driving Equipment.....	29 CFR 1926.603
Site Clearing .....	29 CFR 1926.604
Marine Operations and Equipment .....	29 CFR 1926.605
Definitions .....	29 CFR 1926.606

## **Equipment: General Requirements**

[29 CFR 1926.600]

**Parking.** If heavy equipment is left at night adjacent to a highway that is in normal use, then there must be lights or reflectors on the equipment or on a barricade.

Whenever equipment is parked, set the parking brake. If it's on a hill, you must also use chock blocks.

**Split Rims.** If you work on tires that mount on split rims, you must use a safety cage. This includes inflating, mounting, or dismounting tires installed on split rims.

**Raised Equipment.** If a piece of heavy machinery is jacked up, or suspended by slings, it must also have blocks or cribbing before anyone works underneath.

If repair work is done on bulldozer or scraper blades, end-loader buckets, dump bodies, or similar equipment, fully lower the equipment, or support it with blocks. Set all controls in neutral.

**Charging Batteries.** Be careful when charging batteries. The hydrogen gas which they make when charging can explode. Also, the electrolyte can burn you or cause blindness. Follow the safe work practices specified in the OSHA Electrical Standard. [See 29 CFR 1926.441.]

**Windows.** All glass used in the windows of cabs must be safety glass.

**Power Lines.** If there are power lines near where you are using mechanized equipment, you must maintain a safe clearance distance. The OSHA Crane Standard lists the required safe distances, which depend on the voltage of the power line. [See 29 CFR 1926.550(a)(15).]

**Railroad Cars.** If there is a railroad track on the site, use derailleurs or bumper blocks to assure that railroad cars cannot accidentally roll.

**Brakes.** All vehicles must have three properly working brake systems:

- Service brake system.
- Emergency brake system.
- Parking brake system.

**Lights.** Vehicles that operate at night, or where there is diminished light, must have at least two headlights and two taillights in good working order.

All vehicles must have brake lights in operable condition regardless of light conditions.

**Horn.** All vehicles must have an audible warning device.

**Backing.** No employer shall use any motor vehicle having an obstructed view to the rear unless the vehicle:

- Has a reverse signal alarm audible above the surrounding noise; or
- Is backed up only when a spotter or flagger signals that it is safe to do so.

**Windshields.** Vehicle cabs must have windshields and powered wipers. Cracked or broken glass must be replaced promptly. Except in dry areas where condensation does not occur, windshields must also have defrosters.

**Falling Materials.** If a vehicle is loaded by crane, powered shovel or loader, then there must be a canopy or shield strong enough to protect the operator from falling materials.

**Carrying Passengers.** Vehicles used to transport employees must have a firmly secured seat for each passenger. They must also have seat belts.

## Motor Vehicles

[29 CFR 1926.601]

---

This section applies to motor vehicles that operate on an off-highway job site, not open to public traffic.

---

# Motor Vehicles Continued

[29 CFR 1926.601]

---

This section applies to motor vehicles that operate on an off-highway job site, not open to public traffic.

---

**Dump Bodies.** Trucks with dump bodies must have a positive means of support, permanently attached, and capable of being locked in position to prevent accidental lowering of the body while maintenance or inspection work is being done. The levers controlling the dump body must have a latch to prevent accidental starting or tripping. The trip handle must be placed so that the operator is in the clear.

**Fenders.** Vehicles with rubber tires must have fenders. Mud flaps may be used in lieu of fenders if the vehicle is not designed for fenders.

**Pre-Shift Safety Checks.** All vehicles in use must be checked at the beginning of each shift to assure that the following parts are in safe operating condition and free of apparent damage that could cause failure while in use:

- Service brakes and connections
- Steering
- Parking brakes
- Coupling devices
- Emergency brakes
- Seat belts
- Tires
- Operating controls
- Horn
- Safety devices

All defects must be corrected before the vehicle is placed in service.

This section applies to earth moving equipment, including scrapers, loaders, crawler or wheel tractors, bulldozers, off-highway trucks, graders, agricultural and industrial tractors, and similar equipment.

**Seat belts.** All equipment covered by this section must have seat belts.

Exception: If the equipment is designed only for stand-up operation, seat belts are not required.

**Brakes.** All earth moving equipment must have a service braking system capable of stopping and holding the equipment fully loaded.

**Fenders.** Earth moving equipment that can go 15 mph and that has pneumatic tires, must have fenders.

**Rollover Protective Structures (ROPS).** Many types of earth moving equipment must have rollover protection. This is covered specifically in Subpart W of the OSHA Construction Standard.

**Audible alarms.** Bidirectional machines, such as rollers, compactors, front-end loaders, and bulldozers must have a horn, louder than the surrounding noise.

**Backing.** No employer shall permit equipment to be backed unless it:

- Has a reverse signal alarm audible above the surrounding noise; or
- Is backed up only when an observer signals that it is safe to do so.

**Scissor points.** Scissor points on front-end loaders that create a hazard to the operator during normal operation must have a guard.

# Powered Industrial Trucks

[29 CFR 1926.602(c)]

**Rated Capacity.** Lift trucks, stackers, etc., must have the rated capacity clearly posted on the vehicle. These ratings shall not be exceeded.

No modifications or additions that affect the capacity or safe operation of the equipment shall be made without the manufacturer's written approval. In no case shall the original safety factor of the equipment be reduced.

If a load is lifted by two or more trucks working together, the proportion of the total load carried by any one truck shall not exceed its capacity.

**Spinner Knobs.** Steering or spinner knobs must not be used unless the steering mechanism is designed to safely use a knob. Check with the manufacturer to make sure.

**Passengers.** No unauthorized personnel may ride on powered industrial trucks. **A safe place to ride shall be provided where riding of trucks is authorized.**

**Lifting Personnel.** If a truck is equipped with a platform for lifting personnel then the platform must have:

- Controls that allow the workers on the platform to shut off the truck.
- Protection from falling objects.

**Training.** OSHA adopted a standard which requires special training for workers who operate powered industrial trucks. The standard is 29 CFR 1910.178(l). This module by itself does not fulfill the OSHA training requirements. In order to meet those requirements, operators must have hands-on training on the specific types of industrial trucks they will operate. This module, by itself, does not satisfy the training requirements.

## Vehicle Decontamination

Vehicles that are contaminated with hazardous chemicals (for example, trucks used at hazardous waste cleanup sites) must be decontaminated before leaving the site. Here are some basic principles of vehicle decontamination:

- Keep vehicles and heavy equipment from getting contaminated in the first place. Don't drive through spills or contaminated areas.
- If vehicles must be used near contaminated areas, consider covering the wheels, and other exposed parts with tape and plastic sheeting.
- Have sturdy platforms or other means to safely get at all parts without having to climb on the vehicle.
- Decon workers must have the right protective clothing, respirators and eye protection.
- Be careful when using pressurized sprayers.
- Use decon solutions that are compatible with the chemicals involved, and with the vehicle's paint.
- Provide a means to collect runoff water.
- Usually start at the top and work down.
- Use long handled brushes to get at all parts.
- Pay special attention to the undercarriage and other parts that are hard to see.
- Properly treat and dispose of all waste water.

## Review of Vehicle Safety

Below is a list of important safety procedures that you must always follow when you work around, or operate, vehicles and heavy equipment at construction sites:

- Inspect all equipment before use.
- Do regular inspection and maintenance as scheduled.
- Follow the site's traffic management plan.
- Stay on equipment until it stops.
- Use roll over protection (roll bars, etc.).
- Use cab shields or protective canopies on equipment loaded by crane, power shovel or loader.
- Use extreme caution on slopes or near excavations.
- Use a safety tire rack to work on tires with split or locking-ring rims.
- Block wheels and set brakes on parked vehicles.
- Beware of rotating equipment — watch for loose clothing.
- Listen for backup alarms.
- Be seen — wear a high visibility vest.